

Detex Corporation, 302 Detex Drive, New Braunfels, Texas 78130-3045
 (830)629-2900 / 1-800-729-3839 / Fax (830)620-6711
 E-MAIL: detex@detex.com INTERNET: www.detex.com

INSTALLATION INSTRUCTIONS FOR THE EAX-300 DOOR PROP / DOOR CHIME (EAX-300 / 300W / 300SK)

The Detex EAX-300 is designed for applications that require a door prop alarm device on secured doors. The alarm, with approximately 100dB, will sound when someone attempts to keep the door open beyond the selected time. The EAX-300, with it's smaller size makes it the choice for quick and easy installations on emergency exit and restricted doors.

U.S. PATENT NUMBERS:

20050257389
 20050231363
 20050223764



Drawing # 105830

Parts breakdown depiction (Mortise cylinder required)

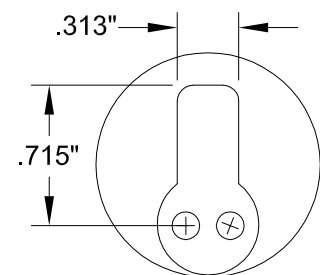
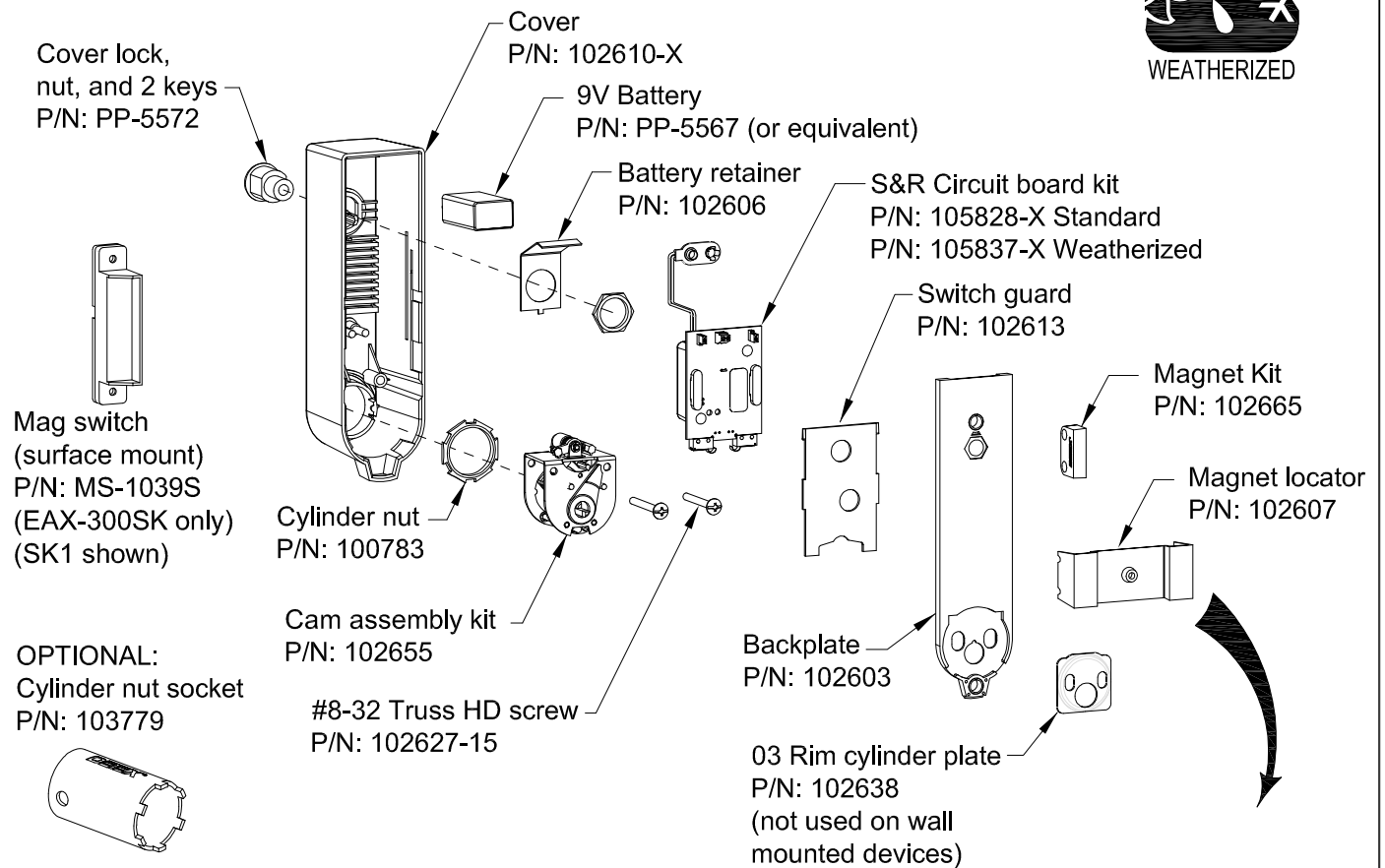

Mortise Cylinder with standard Yale cam required



Locate this component for Step 6

Device will vary based on configuration and order options.

STEPS 1-5: PREP DEVICE

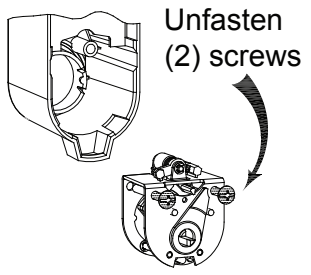
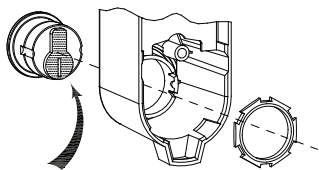
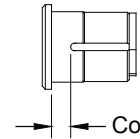
1 Remove cam assembly from cover	2 Install mortise cylinder with cylinder nut provided NOTE: For "Key Stop", See Step 9
 <p>Unfasten (2) screws</p>	<div style="display: flex; justify-content: space-between;"> <div data-bbox="604 262 1031 575"> <p>Mortise cylinder</p>  <p>Cam orientation as shown with key removed</p> </div> <div data-bbox="1031 262 1492 575"> <p>If 7-pin cylinder is used - OBSERVE</p>  <p>Collar required if distance is greater than 5/16". Optional collar can be ordered from Detex (p/n: ECL-1595)</p> </div> </div>

3 Re-install cam assembly	4 Set selector switch functions (See Table A)	5 Connect 9-volt battery and install as shown
 <p>Set OKC cam as shown</p>	<p>DP (OFF) (Default settings shown) STATUS INDICATOR (OFF)</p> 	 <p>CORRECT</p> <p>WRONG</p>

Table A: Selector Switch Functions (*Default settings; **Will shorten battery life)		
STATUS INDICATOR (SWITCH B)	OFF*	No indication that device is armed or disarmed.
	ON	ARMED - red LED blinks approximately every 6 seconds.** DISARMED - green LED blinks approximately every 6 seconds.**
DP (SWITCH A)	OFF*	Door prop mode
	ON	Door chime mode

STEP 6: For all models except SK DOOR PREP & BACKPLATE / MAGNET MOUNTING

Mark/drill backplate and magnet holes on door and frame/mullion

NOTE: Remove locator and backplate prior to drilling mounting holes

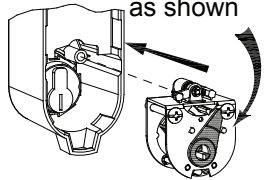
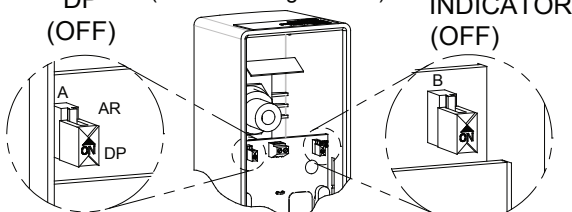
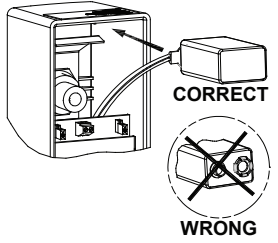
Backplate

Drill #7 for #1/4-20 machine screws
Drill 7/32" or 3/16" for #14 sheetmetal screws

Magnet

Drill #43 for #4-40 machine screws
Drill #44 for #4 sheetmetal screws

Backplate

Drill #7 for #1/4-20 machine screws
Drill 7/32" or 3/16" for #14 sheetmetal screws

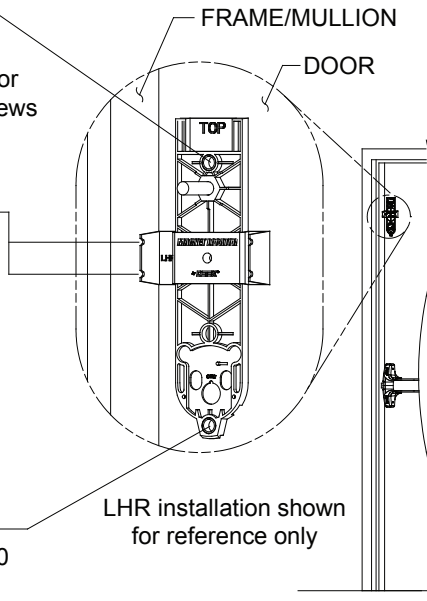

Install magnet, backplate and cover

Install magnet with (2) #4-40 or #4 screws

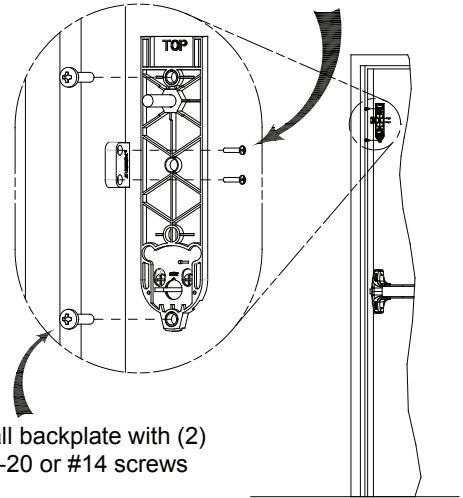

Install backplate with (2) #1/4-20 or #14 screws

Skip to Step 8 to continue non SK installation

STEP 6: For SK models BACKPLATE MOUNTING

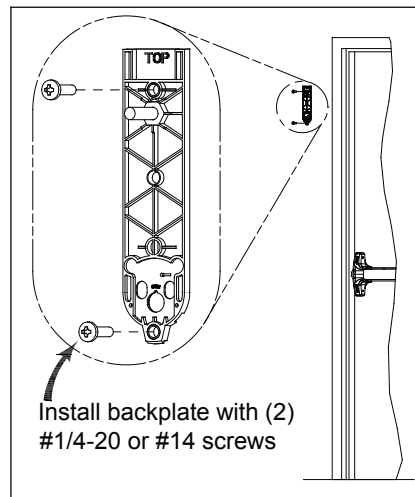

Install backplate with (2) #1/4-20 or #14 screws

STEP 7: Multi-door & SK function wiring connection (if required)

(Recommended installation)

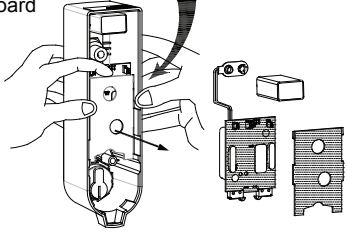
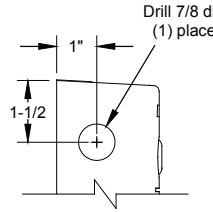
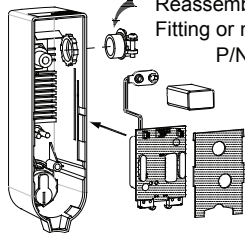
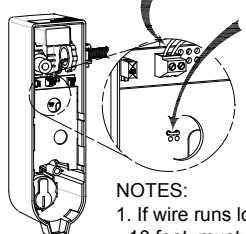
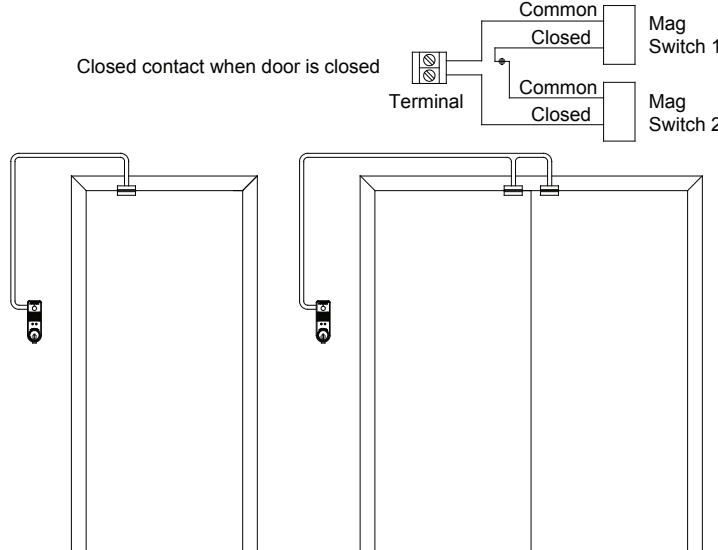
<p>7a Flex walls outward to remove guard & board</p> 	<p>7b Recommended hole size</p> 	<p>7c Reassembly: Fitting or nut NOT included P/N: PP-5107</p> 
<p>7d Screw wires to (P1) terminal block (18ga Max wire dia)</p> <p>Disconnect power & cut (JP1) jumper (see note 3 below)</p>  <p>NOTES:</p> <ol style="list-style-type: none"> 1. If wire runs longer than 10 feet, must use twisted pair 2. 1/16" slotted jeweler screwdriver required. 3. If internal contact is used DO NOT cut jumper (JP1) 		<p>Diagram shown typical for two door magnetic switches: MS-1039S & MS-1059S wire in series. MS-2049 (Red wire not used)</p> <p>Weatherized not available for SK installations</p> 

STEP 8: INSTALL DEVICE

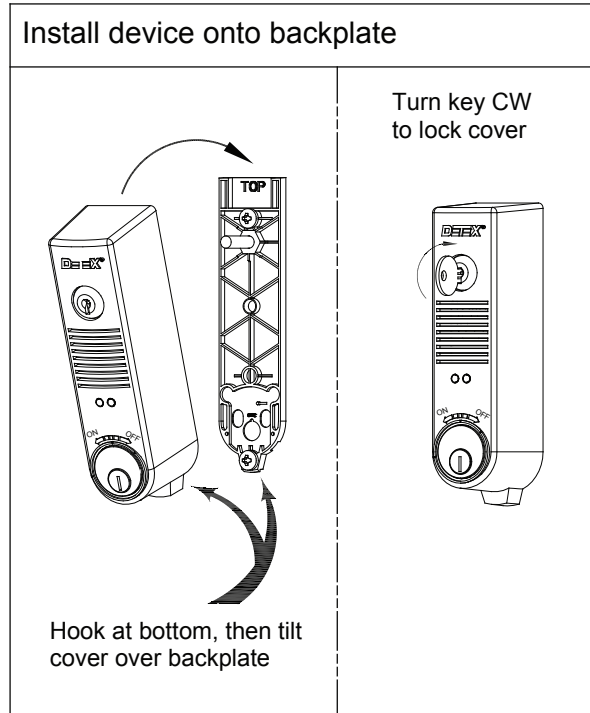

STEP 9: KEY STOP INSTALLATION (Key stop included in hardware kit)

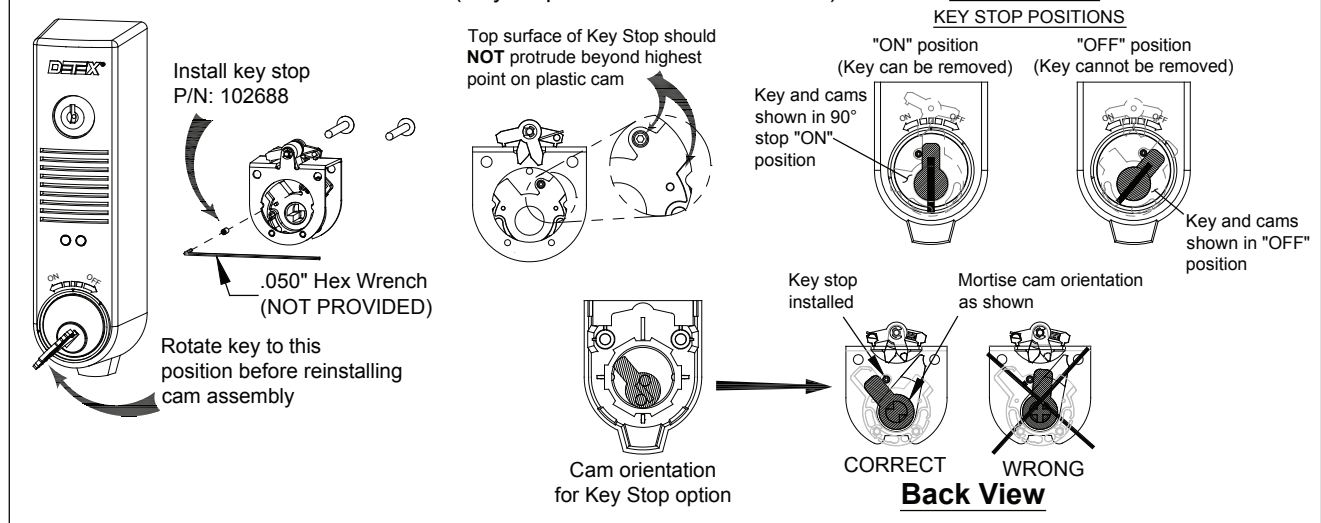

OPERATIONS

SPECIAL NOTES and DEFINITIONS:

1. The door needs to be closed to test the unit.
2. When operating the ON/OFF switch, there is a slight delay.
3. The key is inserted and removed only in the vertical position (home position).
4. Key function: counter clockwise (CCW) = Armed; clockwise (CW) = Disarmed
5. The door prop function is selectable by setting SWITCH A to the OFF position.
For door chime function, set SWITCH A to the ON position

MAGNET HANDING PROCEDURE: Magnet handing is where the device determines if the left, right or an external reed switch will be used to indicate if the door is opened or closed. When the battery is initially installed, the device simultaneously flashes the LEDs and chirps the siren a total of five times. This indicates that the device is in the magnet handing process:

- Step 1: If re-handing is necessary, remove the unit from the door, momentarily short the REHANDING (or *Test*) jumper contacts. The device simultaneously flashes the LEDs and chirps the siren a total of five times.
- Step 2: Turn the key CW to the 'OFF' position.
- Step 3: Install the device on the door.
- Step 4: With the door open, turn the key CCW to the 'ON' position. The red LED blinks twice.
- Step 5: Close the door and bring the external magnet into position with the external door switch.
The siren chirps and the LED flashes on the selected side of the device (red LED flashes for the left side or external; green LED flashes for right side).

The device will now operate normally, and the selected reed switch side is stored in memory so changing the battery does not require re-handing.

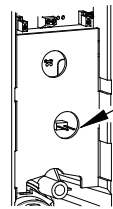

REHANDING
(or *Test*) jumper
contacts.

DOOR PROP OPERATIONS: The door prop function is selected by setting SWITCH A to the 'OFF' position. To arm the system, close the door and turn the key CCW to the 'ON' position. The red LED will flash twice indicating that the device is now armed. If the door is opened, the device will begin a timing countdown according to the selected amount of time (15 seconds default). If the *Status Indicator* (switch B) is 'ON', the red LED will blink every second during the countdown. If the door is not closed before the door prop time runs out, the alarm sounds and the red LED flashes. Closing the door will silence the alarm and rearm the unit. To change the door prop timing, see the section **Changing Door Prop Timing**.

DOOR CHIME OPERATIONS: The door chime function is selected by setting SWITCH A to the 'ON' position. To arm the system, close the door and turn the key CCW to the 'ON' position. The red LED will flash twice indicating that the device is now armed. If the door is opened, the device sounds a series of siren chirps lasting five seconds. No other action is taken until the door is closed and the unit rearms.

DISARMING: To turn off the alarm or disarm the system, turn the key CW to the 2 o'clock position.

TROUBLESHOOTING: If the unit does not arm, the magnet may need to be re-aligned or shimmed closer to the EAX-300. If the unit fails to operate correctly, restart the device by removing the battery for approximately five seconds.

LOW BATTERY ALERT: Simultaneous siren chirps and red LED flashes occur at 45 second intervals when battery reaches approximately 7 volts. The *LV Opt* jumper must be in place to use this feature (default).

STATUS INDICATOR: With the Status indicator (SWITCH B) 'ON': red LED flashes every six seconds when armed; green LED flashes every six seconds when disarmed.

Key orientation
without Key Stop
installed

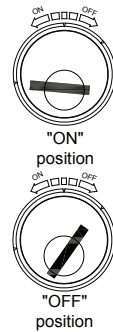

Key orientation
with Key Stop
installed



LV Opt jumper
behind cover
(under SWITCH A)

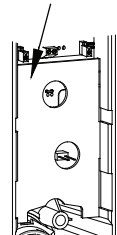

CHANGING DOOR PROP TIMING: Note: *Device must be magnet handed. *LED indications will flash a total of 3 times before the timing is changed.

Step 1: Turn the key CW to the 'OFF' position, remove the unit from the door and disconnect the battery.

Step 2: Turn the key CCW to the 'ON' position.

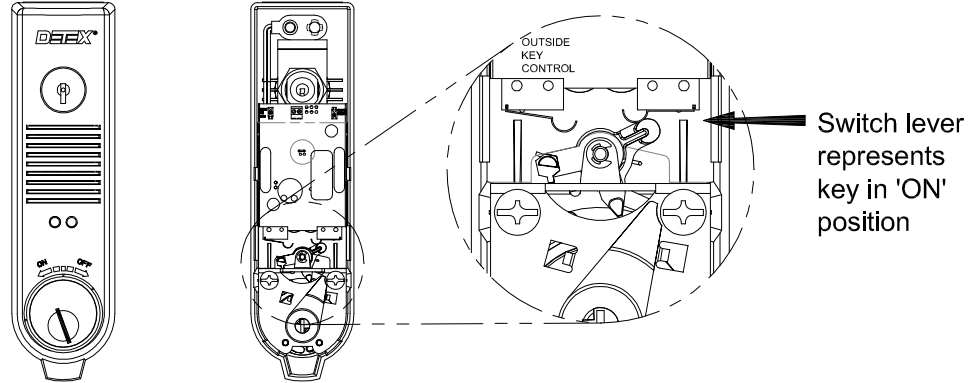

Step 3: While holding the OKC lever in the closed position (by rotating lever to the left stop), reconnect the battery. The device will chirp the siren once and the LEDs will flash the currently selected door prop time (See Table B). Release the OKC switch lever and turn the key to the 'OFF' position.

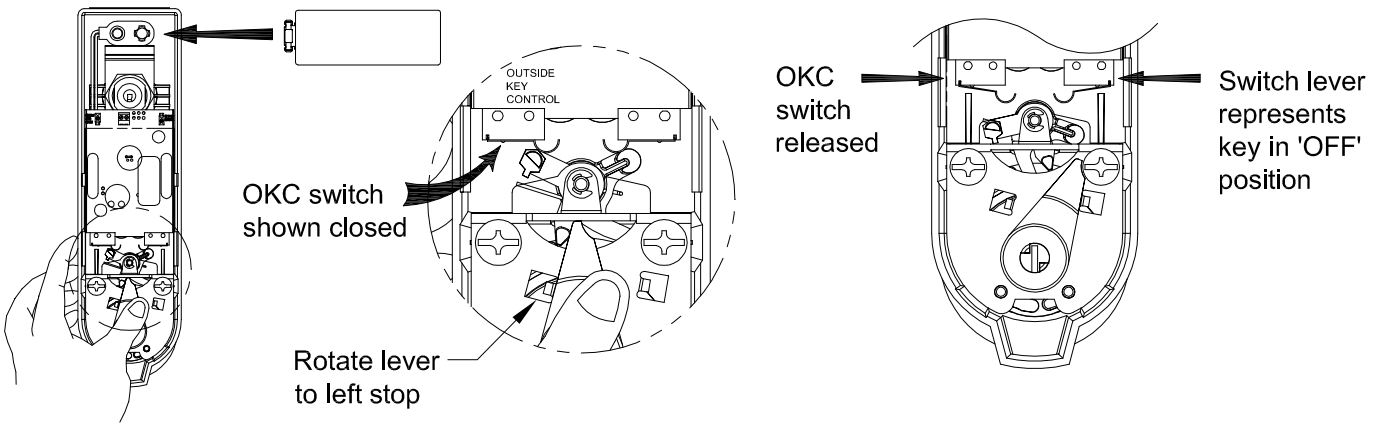

Step 4: Close then release the OKC switch lever to cycle to the next highest door prop time. Table B lists the available door prop times and their corresponding LED indications. For example, to indicate the default 15 second door prop time, the red LED would flash once, followed by 5 green LED flashes. To indicate 2 minutes, the red and green LEDs would flash simultaneously two times. Once the desired timing is selected, wait approximately 15 seconds for the unit to flash the selection three times. The timing has successfully been changed upon hearing the siren chirp four times. This new timing selection is retained in memory even with battery removal.

Table B	
Door Prop Timer	LED indication
1 second	1 GREEN flash
15 seconds (Default)	1 RED flash - 5 GREEN flashes
30 seconds	3 RED flashes
45 seconds	4 RED flashes - 5 GREEN flashes
1 minute	1 RED & GREEN simultaneous flash
2 minutes	2 RED & GREEN simultaneous flashes
4 minutes	4 RED & GREEN simultaneous flashes

Step 5: Reinstall the device on the door.

Optional Accessories

Inswing Door Kit
P/N: 102664

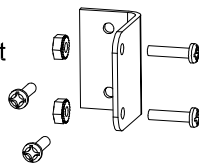

Cylinder Nut Tool
P/N: 103779

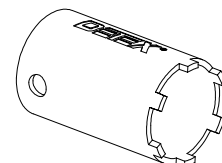

TROUBLESHOOTING

PROBLEM	PROBABLE CAUSE	ACTION
Device is not powering up.	1) Battery not properly installed.	1) Remove battery and firmly reinstall.
Device not arming.	1) Magnet not aligned correctly. 2) Battery is dead. 3) Cylinder had wrong cam installed. 4) Cylinder microswitch lever broken. 5) Cylinder installed incorrectly.	1) Use magnet locator to install magnet. See magnet handing. 2) Replace battery. 3) Requires standard Yale cam. 4) Microswitch needs to be replaced. Remove PCB and return to Detex Repair. 5) Check cylinder installation. Make sure key is turned counter-clockwise all the way to ON.
Chirp every 45 seconds	Low battery	Install new battery.
External magnet not working.	Device is not set for external magnet.	Cut JP1 jumper. With battery connected, short "Test mode" pins, listen for 5 chirps. See RE-HANDING section.
No connector for external magnet.	Weatherized device.	Weatherized device can not be used with external contact.

DOOR PROP

PROBLEM	PROBABLE CAUSE	ACTION
After arming and door is opened, the device chirps 4 times then shuts off.	The device is setup as Door Chime.	Reset device, slide Switch A to the OFF position.

DOOR CHIME

PROBLEM	PROBABLE CAUSE	ACTION
After arming and door is opened, the device blinks red.	The device is setup as Door Prop	Reset device, slide Switch A to the ON position.