

# SDC Security Door Controls

801 Avenida Acaso, Camarillo, Ca. 93012 • (805) 494-0622 •  
www.sdcsecurity.com • E-mail: service@sdsecurity.com

## INSTALLATION INSTRUCTIONS 920 EntryCheck™

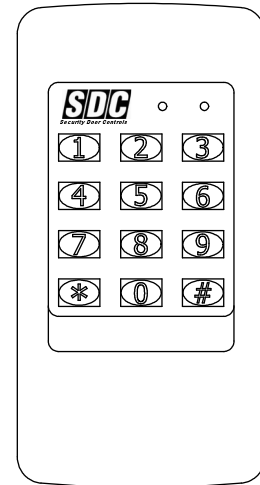

The 920 Indoor/Outdoor Keypad Surface Mount *EntryCheck*™ is a digital keyless entry system designed for access control applications. The keypad is integrated in a heavy cast vandal resistant housing, designed to be mounted on a rugged, surface mounting plate and may be mounted in a standard single-gang electrical box. The indoor/outdoor backlit keys have bright, easy-to-read graphics.

Up to 500 entry codes, from 1 to 6 digits in length, can be programmed. They can activate either, or both of the relay outputs. The “anti-passback” feature prevents using the same code again before the programmed time elapses.

All system indicators are long-lasting, solid state LEDs. Two indicators show the status of the entry system. The left indicator lights red to indicate power, then turns green when access is granted. The right indicator lights yellow when the keypad is in “lockout” condition (from too many incorrect code entries). The yellow LED flashes when the keypad is in programming mode. An internal sounder beeps when each key is pressed. An internal jumper sets the sounder volume high or low

The **SENSE** input can be used two ways. If programmed for “door sense” the input is wired to a normally closed switch on the door to detect when the door is opened or closed. Forced entry or door ajar situations can then be detected. Using door sense, the “Auto-relock” feature will prevent “tailgating” by turning off the Main Relay output immediately when the door is closed after access has been granted. If the **SENSE** input is programmed for “inhibit”, the input can be wired to a “service” switch or automatic timer that will disable the Main Relay when required.

The **REQUEST-TO-EXIT** input can be wired to a pushbutton to provide codeless activation of Main Relay, Auxiliary Relay, Output #3 or Output #4 (programmable).

The **ALARM SHUNT** output activates when access is granted. This output can be wired to shunt alarm contacts on the access door/gate to prevent triggering of an alarm when authorized access occurs.

The 920 *EntryCheck*™ is powered from a 12-24V AC or DC source. The EEPROM memory retains all entry codes and programming, even without power. An internal jumper is provided to reset the master code. The Main Relay has a 5 Amp capacity. The Auxiliary Relay has a 2 Amp capacity. Two solid state outputs, capable of switching 100 mA to common, are programmable to signal forced entry, door ajar, lockout, alarm circuit shunting, request-to-exit, and keypad active conditions.

### Features

- Keypad programmable
- 500 user codes
- 1 to 6 digit user codes
- 4 independent outputs
- 4 independent timers
- 2 Form C relay contacts
- 2 solid state open collector outputs
- Program entry codes to activate one or two relays
- Disable input
- Door sense input
- Request-to-exit/enter input
- Keypad tamper lockout
- Timed anti-passback
- Anti-tailgate
- Two LED status indicators
- Tactile key feel
- Audible code entry verification
- 12 or 24V, AC or DC operation

### SPECIFICATIONS

#### Mechanical

Dimensions: 3.00" W x 5.75" H x 1.375" D  
(1.4375" wall projection)

#### Electrical

Input Voltage: 12-24 Volts AC or DC

Operating Current: 30 mA typical, 150 mA max

#### Output Ratings

Main Relay: Form “C” 5 Amps @ 28 Volts max

Auxiliary Relay: Form “C” 2 Amp @ 28 Volts max

Type: Solid state outputs (Outputs #3 & #4)

Short-to-common 100 mA @ 24 VDC maximum

#### Environmental

Temperature: -22°F to 149°F (-30°C to 65°C)

Humidity: 5% to 95% non-condensing

Any suggestions or comments to this instruction or product are welcome. Please contact us through our website or email [engineer@sdsecurity.com](mailto:engineer@sdsecurity.com)

## QuickStart Programming

To enter Programming Mode, enter #9# plus the Master Code. The yellow indicator will blink slowly showing that the 920 EntryCheck™ is in programming mode. Use the option codes to program each function. After the new data entry is complete for each function, the yellow indicator will flash quickly while the data is being stored and the green indicator will light briefly if the programming has been accepted. The red indicator will light if any programming data is entered incorrectly or the function is rejected. If a red indicator is seen, the entire function (option code + data) will have to be fully re-entered.

### Program the first user code

- Step 1. Enter: **#9# 123456** Enter the program mode (default master code)
- Step 2. Enter: **03# 4#** Set the entry code length to 4 digits
- Step 3. Enter: **21# 5#** Set the main relay activate time to 5 sec.
- Step 4. Enter: **01# 9876# 9876# 1#** Set user code '9876' to activate the main relay
- Step 5. Enter: **\*\* #** Exit programming mode

### Test your new user code

Enter user code '9876'. The green indicator should illuminate, the main relay should activate and the door should unlock for 5 seconds.

### Adding additional user codes

Once the code length and relay time have been set you do not need to set them each time you add additional users.

To add additional users:

- Step 1. Enter: **#9# 123456** Enter the program mode (default master code)
- Step 2. Enter: **01# 2222# 2222# 1#** Set user code '2222' to activate the main relay
- Step 3. Enter: **01# 3333# 3333# 1#** Set user code '3333' to activate the main relay
- Step 4. Enter: **\*\* #** Exit programming mode

### Deleting a user code

To delete a user:

- Step 1. Enter: **#9# 123456** Enter the program mode (default master code)
- Step 2. Enter: **02# 3333# 3333#** User code '3333' has been deleted.
- Step . Enter: **\*\*#** Exit programming mode

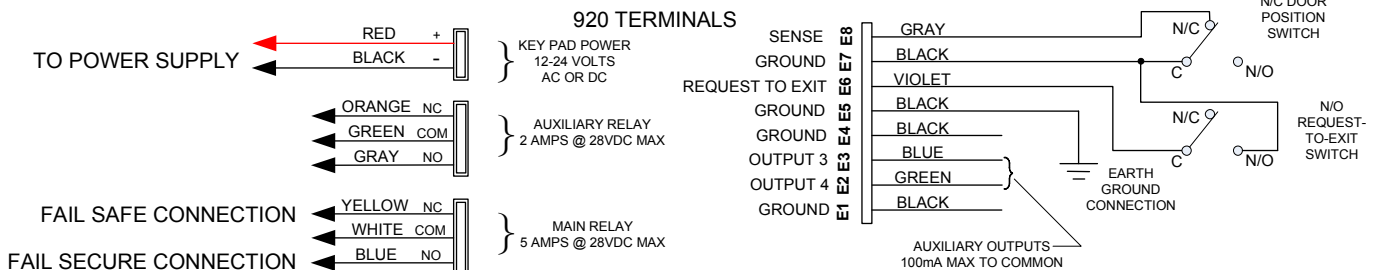
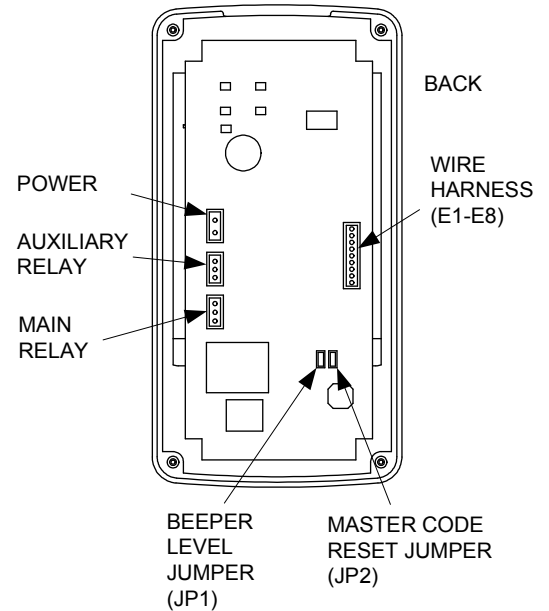
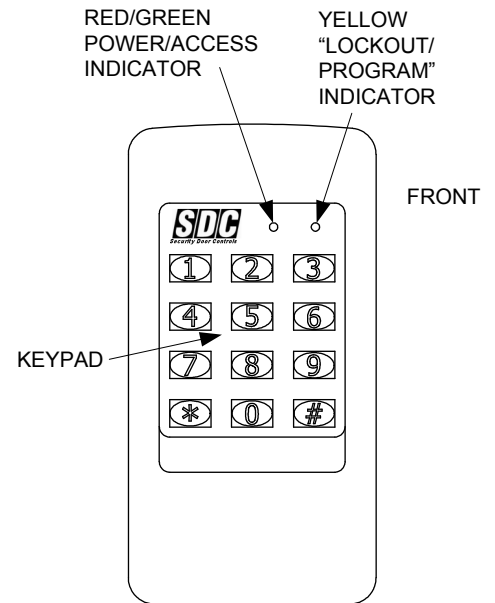

Fig. 2 Wiring Pigtail Color Code



IF THE UNIT IS AC POWERED, MAKE SURE THAT THE SECONDARY OF THE SYSTEM IS ISOLATED FROM EARTH GROUND

## KEYPAD WIRING

See Fig. 3 for an example of a basic door installation. The keypad is mounted adjacent to the door. An electric door strike is mounted in the door jamb to release the door lock. A magnetic switch is mounted on top of the door jamb for detecting when the door is open.

Use the following steps to wire the keypad. Refer to the wiring diagram shown in Fig. 4 to assist in the wiring.

*Note: Up to 500 feet of 18 AWG wire can be run for power, use larger wire for longer runs. Use 22 AWG or larger (depending on load) for other connections.*

### Output

- ❑ Install a low voltage electric door strike for unlocking the door.
- ❑ Route two wires between the door strike and the keypad box.
- ❑ Connect a MOV or varistor across the coil wires of the strike.
- ❑ Connect the (+) door strike wire to the keypad's MAIN RELAY N.O. blue wire. Connect the other door strike wire to the keypad's PWR black wire (-). Connect a wire between the keypad's PWR red wire (+) and the MAIN RELAY COM white wire.

### Power

- ❑ Choose a location for the DC power supply or AC transformer.
- ❑ Route two wires between the door strike and the keypad box. Connect the power supply's output terminals to the keypad's PWR red (+) and black (-) input wires. Observe wiring polarity if using DC. If AC is being used, polarity does not matter.

*Caution: If the unit is AC powered, make sure the secondary of the system transformer is isolated from earth ground.*

### Earth Ground

- ❑ To avoid damage to the unit from static discharges, connect the EARTH GROUND black wires E1, 4, 5 or 8 to a good earth grounding point. Suggested wiring size is 18 AWG for earth ground.

### Sense Input

*RE Note: The SENSE input (gray wire) can be programmed for either a door sense or inhibit input. Both features cannot be used at the same time. If you are not using the sense input, program the input for inhibit.*

- ❑ To use the door sense feature to detect forced entry or door ajar conditions, install a normally closed door switch on the door and route two wires from the switch to the keypad box. Connect the door switch to the keypad's SENSE terminal (gray wire E8) and COM terminal (any black wire).
- ❑ If an inhibit switch or timer is going to be used for temporarily disabling the keypad, route two wires from the switch or timer to the keypad box. Connect the inhibit switch/timer normally open terminals to the keypad's SENSE (gray wire E8) and COM (black wires) terminal.

### Request-to-Exit Input (wiring shown on page 3, fig. 4)

- ❑ If a request-to-exit pushbutton is going to be used, route two wires from the keypad box to a normally open pushbutton mounted on the secure side of the door. Connect the wires to the pushbutton and to the keypad's REX (violet wire E6) and COM (black wires) terminals.

### Solid State Outputs

The two solid state outputs (Outputs #3 & #4) can be programmed to activate during various conditions. These outputs can be used to activate indicators or sounders. See fig. 5 for wiring examples using the solid state outputs.

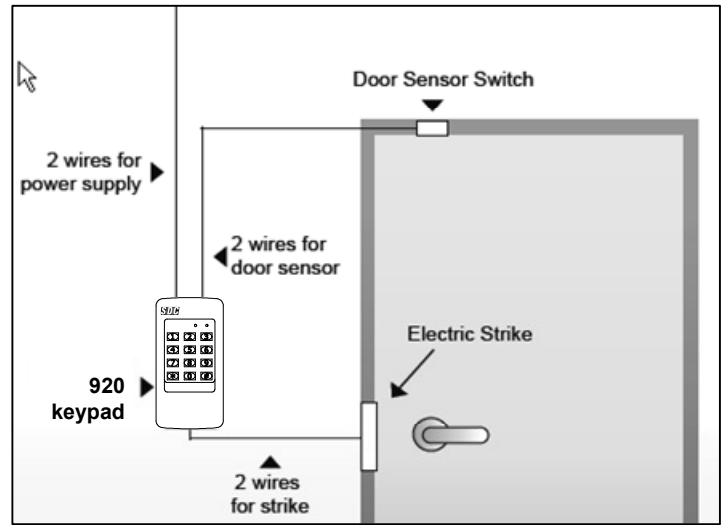

Fig. 3 Basic Door Installation

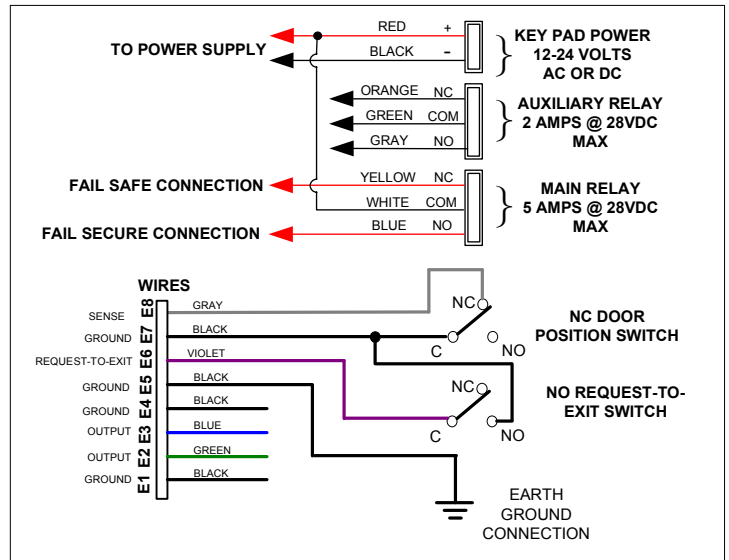

Fig. 4 Basic Door Installation Wiring

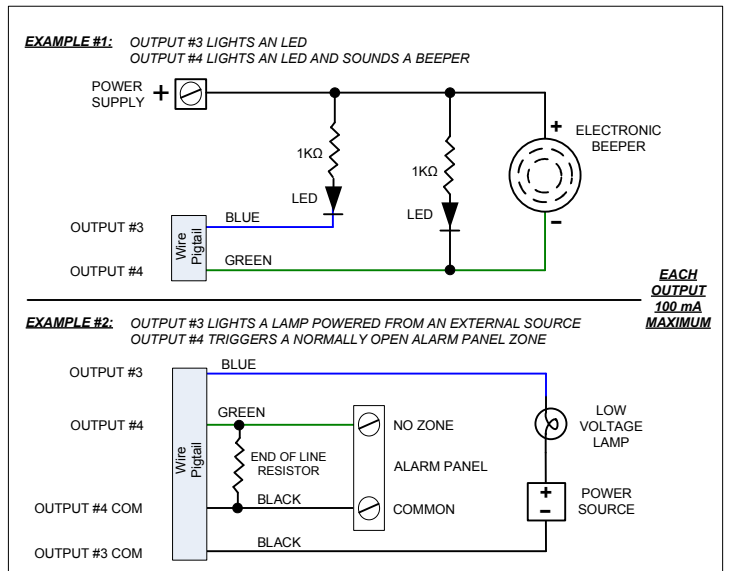

Fig. 5 Using Solid State Outputs

## FACTORY DEFAULTS

Master Programming Code.....	123456
Entry Code Length.....	4 digits
Request-to-exit Output Relay.....	Main Relay
Alarm Shunt Output.....	Disabled
Forced Entry Output.....	Output #3
Door Ajar Output.....	Output #4
Main Relay On Time.....	02 Seconds
Auxiliary Relay On Time.....	02 Seconds
Solid State Output #3 On Time.....	02 Seconds
Solid State Output #4 On Time.....	02 Seconds
Door Sense/Inhibit Input.....	Door Sense
Keypad Lockout Output.....	Disabled
Keypad Active Output.....	Disabled
Beeper Sounds When Key Pressed.....	Yes
Beeper Sounds During Relay #1.....	No
Beeper Sounds During Relay #2.....	No
Beeper Sounds During Output #3.....	No
Beeper Sounds During Output #4.....	No
Keypad Lockout Count.....	3 Tries Before Lockout
Anti-Passback Time.....	No Anti-Passback
Auto-Relock.....	On

## BASIC PROGRAMMING

When the 920 EntryCheck™ is in Programming Mode, both indicators will turn off until programming begins. After a programming option number is entered, the yellow indicator will blink. This shows that the 920 is ready to accept the new programming data. After the new data entry is complete, the yellow indicator will flash while the data is being stored. The green indicator will light if the data is accepted. The red indicator will light if any programming data is entered incorrectly, and the command will have to be fully re-entered.

### Entering Programming Mode

The 6-digit Master Programming Code (default = 123456) is used to enter Programming Mode.

**Press: # 9 # Master Code**

*Master Code = the current 6-digit Master Programming Code*

### Exiting Programming Mode

**Press: \*\*#**

The red indicator will light after exiting Programming Mode

**Note:** *The 920 will automatically exit Programming Mode after two minutes of inactivity*

### Re-entering a Command After a Mistake

If the red indicator lights, signaling an incorrect entry, or an incorrect key is pressed during programming, to clear the keypad and re-enter the command:

**Press: \* 9 #**

### Setting Entry Code Length

**Default: 4 digits**

**Press: 0 3 # Length #**

*Length = 1-6 for entry code length*

**Note:** *If the Entry Code Length is going to be changed from the factory default of 4 digits, make this change first before programming any entry codes.*

## Adding a New Entry Code

**Press: 0 1 # Code # Code # Relay #**

**Code=***The new entry code: 1-999999, depending on code length*

**Relay=***Relay output entry code will activate:*

*1=Main Relay 2=Auxiliary Relay 3=Both Relays*

*10=Relay #1, toggled 20=Relay #2, toggled 30=both Relays toggled*

*12=Relay #1 toggled; Relay #2 timed open*

*21=Relay #1 timed open; Relay #2 toggled*

The yellow indicator will flash quickly while the 920 searches its memory for available space and duplicate entries. The green indicator will light when the new code is stored.

If the new entry code chosen is already being used for another entry code, the red indicator will light. A new unique code needs to be entered.

**Note:** *Leading zeros (zeros before the code number, i.e.0001) do not need to be entered when programming a new code. The 920 will internally add any zeros to fill digits determined by the entry code length setting. Leading zeros will have to be entered by the user when entering their code to gain access.*

## Erasing a Single Entry Code

**Press: 0 2 # Code # Code #**

**Code=***The entry code to delete*

The yellow indicator will flash quickly while the 920 searches its memory for the code to erase. The green indicator will light when the code is erased.

## Erasing All Entry Codes

**WARNING: PERFORMING THIS COMMAND WILL REMOVE ALL ENTRY CODES FROM THE MEMORY**

**Press: 9 7 # 0 0 0 0 0 # 0 0 0 0 0 #**

**Note:** *The green indicator will light while the memory is being erased. This may take up to 15 seconds.*

## Changing the 6-Digit Master Programming Code

**Press: 9 8 # Master Code # Master Code #**

**Master Code=***The new 6-digit Master Programming Code*

New master code: \_\_\_\_\_

## PROGRAMMING OPTIONS

There are several 920 EntryCheck™ programming options. For most installations, the factory set default options are sufficient. The keypad must be in Programming Mode to make these changes.

### Programming the 920 To Hold the Output

SDC's EntryCheck™ products have a programmable "Toggle Mode" available for each relay and solid-state output. When an output is programmed for Toggle Mode, the output alternates from OFF to ON or from ON to OFF each time it is activated. When output is toggled on, the green LED flashes until toggled off.

The rules for a toggle output are:

- *If the output is OFF, it will turn ON and stay on until the next activation.*
- *If the output is ON, it will turn OFF and stay off until the next activation.*

**(Typical Programming cont.)**

Program all normal entry codes to use the Main Relay (Relay #1), and only Relay #1 as the output relay. Program the code(s) that you want to use to hold the output for an indefinite period to the Auxiliary Relay (Relay #2). See the following example that sets entry codes 1234 for normal and 5678 for toggle operation.

**Press: 0 1 # 1 2 3 4 # 1 2 3 4 # 1 #**

*01=Programming Step; 1234=Entry Code; 1=Main Relay*

**Press: 0 1 # 5 6 7 8 # 5 6 7 8 # 20 #**

*01=Programming Step; 5678=Entry Code; 20=Auxiliary Relay toggle*

**Typical Toggle Mode Wiring**

For devices triggered by a normally open circuit, wire the contacts of the Main and Auxiliary Relays in parallel (see the Figure below). Either relay will be able to trigger the access device. Entry codes programmed for the Auxiliary Relay will be able to hold the output on.

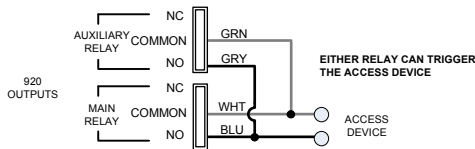

**Select Door Sense or Inhibit Input**      **Default: Door Sense**

The Sense Input (gray wire) can be programmed for either DOOR SENSE or INHIBIT.

**Press: 1 0 # Input #**

*Input=0 for Door Sense; =1 for Inhibit*

When programmed for DOOR SENSE, if an open condition on the input occurs before access is granted (with an entry code or with the request-to-enter input) a FORCED ENTRY output will occur. If an open condition remains after a relay activation for access, a DOOR AJAR output will occur.

When programmed for INHIBIT, a closed condition on the input will prevent Relay #1 from activating when access is requested with an entry code. This mode is typically used with an external timer to disable the access device at certain times.

**Select Forced Entry Output**      **Default: Output #3**

Sets which output activates if the DOOR SENSE input opens before access is granted. This output is not timed.

**Press: 1 1 # Output #**

*Output=Output to Activate(0-4)*

*1=Main Relay; 2=Auxiliary Relay; 3=Output #3; 4=Output #4; 0=No Output*

**Select Door Ajar Output**      **Default: Output #4**

Sets which output activates if the DOOR SENSE input stays open 60 seconds after access is granted. This output is not timed.

**Press: 1 2 # Output #**

*Output=Output to Activate (0-4)*

*1=Main Relay; 2=Auxiliary Relay; 3=Output #3; 4=Output #4; 0=No Output*

**Select Keypad Lockout Output**      **Default: No Output**

Sets which output activates when the keypad is "locked out" after too many incorrect entry code attempts. The lockout time is 60 seconds.

**Press: 1 3 # Output #**

*Output=Output to Activate (0-4)*

*1=Main Relay; 2 = Auxiliary Relay; 3=Output #3; 4=Output #4; 0=No Output*

**Select Keypad Active Output**      **Default: No Output**

Sets which output activates when any keys are pressed. This output is timed. If toggle mode is selected for the output, the timer value defaults to 2 seconds.

**Press: 1 4 # Output #**

*Output=Output to Activate(0-4)*

*1=Main Relay; 2=Auxiliary Relay; 3=Output #3; 4=Output #4; 0=No Output*

**Select Alarm Shunt Output**      **Default: No Output**

Sets which output activates during the time access is granted. (Use this output of shunt alarm contacts attached to the access door.) This output may be timed or toggled.

**Press: 1 5 # Output #**

*Output=Output to Activate(0-4)*

*1=Main Relay; 2=Auxiliary Relay; 3=Output #3; 4=Output #4; 0=No Output*

**Select Request-to-Exit Output**      **Default: No**

Sets which output activates when the Request-to-Exit input is grounded. This output may be timed or toggled.

**Press: 1 6 # Output #**

*Output=Output to Activate(0-4)*

*1=Main Relay; 2=Auxiliary Relay; 3=Output #3; 4=Output #4; 0=No Output*

**REX input terminates toggle of Main Relay**

**Main Relay On-time**      **Default: 02 Seconds**

Sets the length of time the Main Relay activates when triggered. Green LED is on when Main Relay is active.

**Press: 2 1 # Seconds #**

*Seconds=Output time in seconds (0-60)*

**Auxiliary Relay On-time**      **Default: 02 Seconds**

Sets the length of time the Auxiliary Relay activates when triggered.

**Press: 2 2 # Seconds #**

*Seconds=Output time in seconds (0-60)*

**Solid-state Output #3 On-time**      **Default: 02 Seconds**

Sets the length of time Output #3 activates when triggered.

**Press: 2 3 # Seconds #**

*Seconds=Output time in seconds (0-60), 99=Toggle Mode*

**Solid-state Output #4 On-time**                      **Default: 02 Seconds**

Sets the length of time Output #4 activates when triggered.

**Press: 2 4 # Seconds #**

*Seconds=Output time in seconds (0-60), 99=Toggle Mode*

---

**Beep Sounds on Keystrokes**                      **Default: 1 Second**

Selects whether or not the keypad beeps as each key is pressed.

**Press: 4 0 # Sound #**

*Sound=1 for Yes, =0 for No*

---

**Beep Sounds During Main Relay**                      **Default: No**

Selects whether or not the keypad beeps during Main Relay activation.

**Press: 4 1 # Sound #**

*Sound=1 for Yes, =0 for No*

---

**Beep Sounds During Auxiliary Relay**                      **Default: No**

Selects whether or not the keypad beeps during Auxiliary Relay activation.

**Press: 4 2 # Sound #**

*Sound=1 for Yes, =0 for No*

---

**Beep Sounds During Output #3**                      **Default: No**

Selects whether or not the keypad beeps during Output #3 activation.

**Press: 4 3 # Sound #**

*Sound=1 for Yes, =0 for No*

---

**Beep Sounds During Output #4**                      **Default: No**

Selects whether or not the keypad beeps during Output #4 activation.

**Press: 4 4 # Sound #**

*Sound=1 for Yes, =0 for No*

---

**Keypad Lockout Count**                      **Default: 3 Tries**

Sets the number of incorrect entry code attempts allowed before the keypad "locks out".

**Press: 5 0 # Attempts #**

*Attempts=Number of attempts before lockout (2-7)*

---

**Anti-Pass Back Time**                      **Default: No Anti-Pass Back**

Sets the length of time an entry code will not function after it is used.

**Press: 5 1 # Minutes #**

*Minutes=Time in minutes (1-4), 0=No Anti-passback*

---

**Selects mode for Keypad LED Backlight**                      **Default: 30 Seconds**

Selects whether or not the keypad back light stays OFF, lights for 30 seconds when activated or stays ON.

**Press: 52 # Output #**

*0 = Light always OFF*

*1 = 30 sec light when activated (default)*

*2 = Light always ON*

---

**RESETTING KEYPAD**

**Master Reset**

***CAUTION: Performing a master reset will clear the entire memory of the 920 and return all programmable options to the factory default values. ALL ENTRY CODES WILL BE ERASED.***

- STEP 1** Disconnect power from the keypad.
- STEP 2** Press and hold down the \* and # keys.
- STEP 3** Apply power to the keypad, continue holding the keys down until the red indicator starts flashing
- STEP 4** Release the keys. The red and yellow indicators will remain lit until the process is complete, then the yellow indicator will go out.

**Resetting the Master Code**

- STEP 1** Remove the 920 from the wall..
- STEP 2** Locate jumper at JP2. This jumper is used to reset the master code.
- STEP 3** With power applied to the keypad, remove the jumper at JP2. The keypad will begin to beep, signaling that the code has been reset.
- STEP 4** Replace jumper on JP2  
THE MASTER PROGRAMMING CODE IS NOW 123456.

**Beeper Sound Level**

The Keypad's beeper can be set to high or low level. Remove jumper JP1 to reduce beeper sound level.

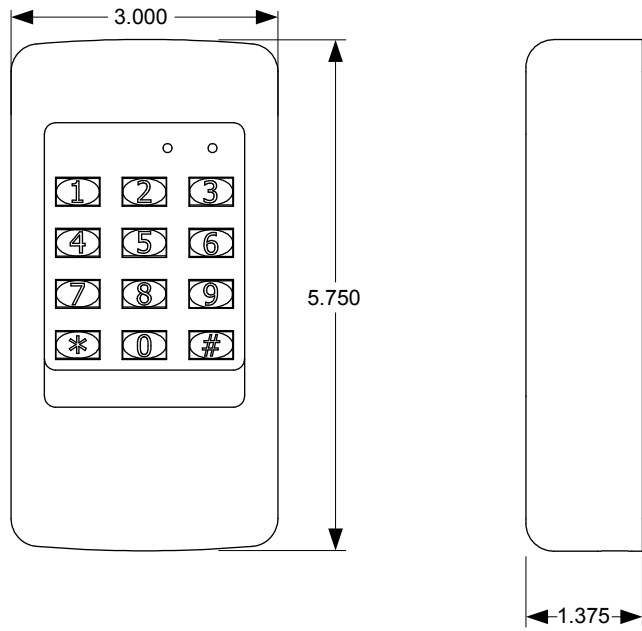

## SURFACE MOUNT

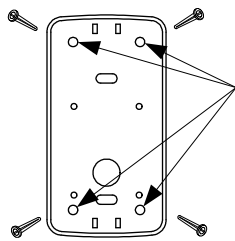

4X Mount at holes  
With supplied  
screws and hole  
expansion anchors

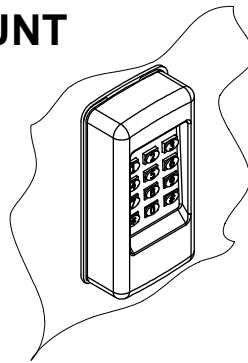

## MOUNTING TO SINGLE GANG RECESSED OUTLET BOX

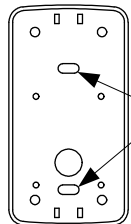

2X  
Mount  
at slots

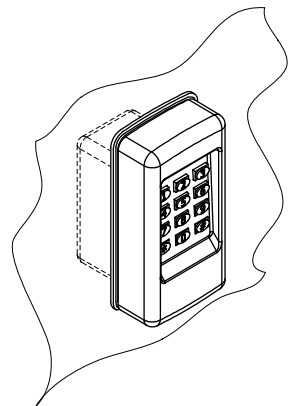
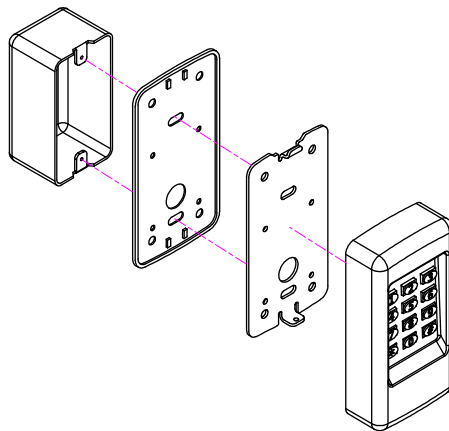

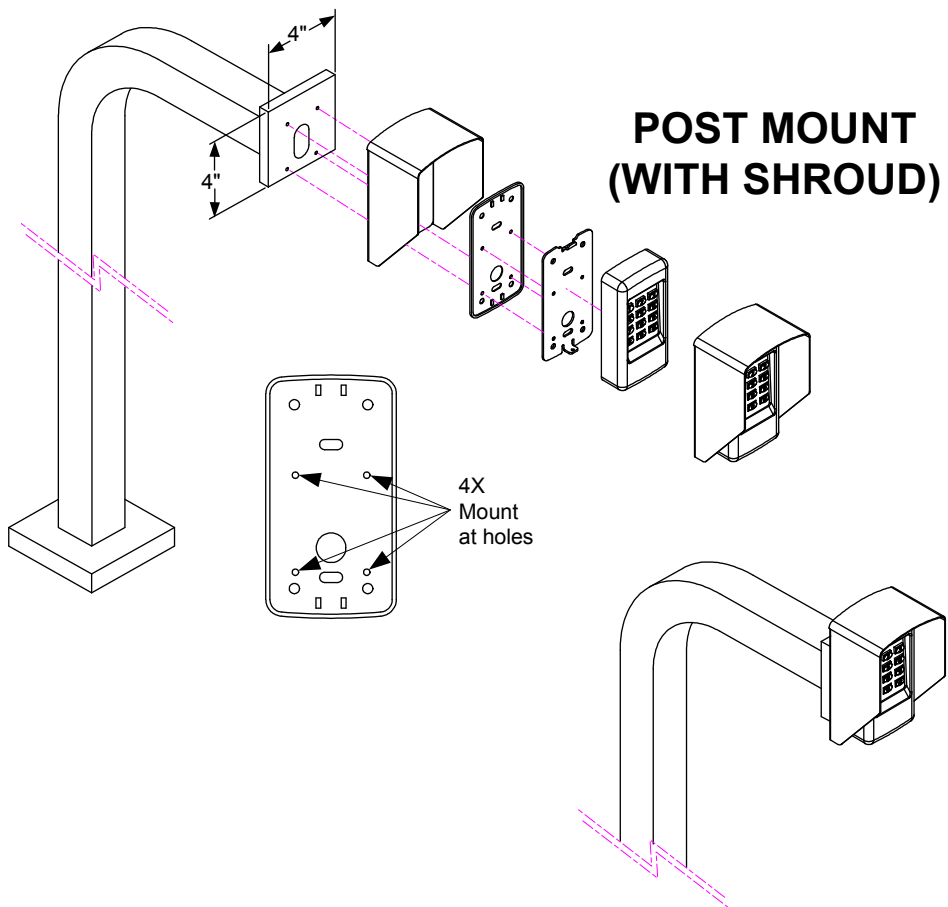
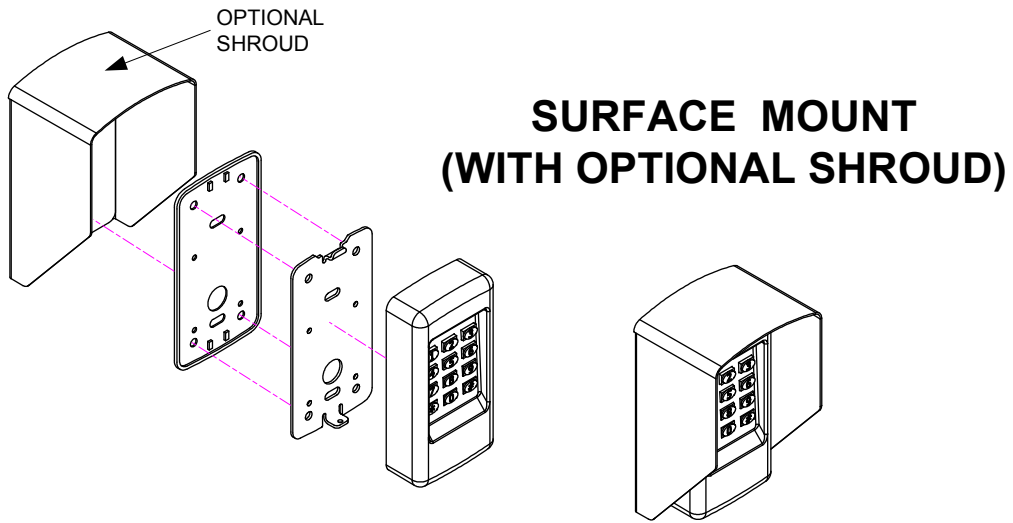



# SDC Security Door Controls

801 Avenida Acaso, Camarillo, Ca. 93012 • (805) 494-0622 •  
www.sdcsecurity.com • E-mail: service@sdsecurity.com

## INSTALLATION INSTRUCTIONS 920 EntryCheck™

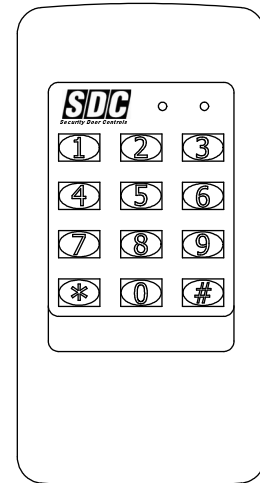

The 920 Indoor/Outdoor Keypad Surface Mount *EntryCheck*™ is a digital keyless entry system designed for access control applications. The keypad is integrated in a heavy cast vandal resistant housing, designed to be mounted on a rugged, surface mounting plate and may be mounted in a standard single-gang electrical box. The indoor/outdoor backlit keys have bright, easy-to-read graphics.

Up to 500 entry codes, from 1 to 6 digits in length, can be programmed. They can activate either, or both of the relay outputs. The “anti-passback” feature prevents using the same code again before the programmed time elapses.

All system indicators are long-lasting, solid state LEDs. Two indicators show the status of the entry system. The left indicator lights red to indicate power, then turns green when access is granted. The right indicator lights yellow when the keypad is in “lockout” condition (from too many incorrect code entries). The yellow LED flashes when the keypad is in programming mode. An internal sounder beeps when each key is pressed. An internal jumper sets the sounder volume high or low

The **SENSE** input can be used two ways. If programmed for “door sense” the input is wired to a normally closed switch on the door to detect when the door is opened or closed. Forced entry or door ajar situations can then be detected. Using door sense, the “Auto-relock” feature will prevent “tailgating” by turning off the Main Relay output immediately when the door is closed after access has been granted. If the **SENSE** input is programmed for “inhibit”, the input can be wired to a “service” switch or automatic timer that will disable the Main Relay when required.

The **REQUEST-TO-EXIT** input can be wired to a pushbutton to provide codeless activation of Main Relay, Auxiliary Relay, Output #3 or Output #4 (programmable).

The **ALARM SHUNT** output activates when access is granted. This output can be wired to shunt alarm contacts on the access door/gate to prevent triggering of an alarm when authorized access occurs.

The 920 *EntryCheck*™ is powered from a 12-24V AC or DC source. The EEPROM memory retains all entry codes and programming, even without power. An internal jumper is provided to reset the master code. The Main Relay has a 5 Amp capacity. The Auxiliary Relay has a 2 Amp capacity. Two solid state outputs, capable of switching 100 mA to common, are programmable to signal forced entry, door ajar, lockout, alarm circuit shunting, request-to-exit, and keypad active conditions.

### Features

- Keypad programmable
- 500 user codes
- 1 to 6 digit user codes
- 4 independent outputs
- 4 independent timers
- 2 Form C relay contacts
- 2 solid state open collector outputs
- Program entry codes to activate one or two relays
- Disable input
- Door sense input
- Request-to-exit/enter input
- Keypad tamper lockout
- Timed anti-passback
- Anti-tailgate
- Two LED status indicators
- Tactile key feel
- Audible code entry verification
- 12 or 24V, AC or DC operation

### SPECIFICATIONS

#### Mechanical

Dimensions: 3.00" W x 5.75" H x 1.375" D  
(1.4375" wall projection)

#### Electrical

Input Voltage: 12-24 Volts AC or DC

Operating Current: 30 mA typical, 150 mA max

#### Output Ratings

Main Relay: Form “C” 5 Amps @ 28 Volts max

Auxiliary Relay: Form “C” 2 Amp @ 28 Volts max

Type: Solid state outputs (Outputs #3 & #4)

Short-to-common 100 mA @ 24 VDC maximum

#### Environmental

Temperature: -22°F to 149°F (-30°C to 65°C)

Humidity: 5% to 95% non-condensing

Any suggestions or comments to this instruction or product are welcome. Please contact us through our website or email [engineer@sdsecurity.com](mailto:engineer@sdsecurity.com)

## QuickStart Programming

To enter Programming Mode, enter #9# plus the Master Code. The yellow indicator will blink slowly showing that the 920 EntryCheck™ is in programming mode. Use the option codes to program each function. After the new data entry is complete for each function, the yellow indicator will flash quickly while the data is being stored and the green indicator will light briefly if the programming has been accepted. The red indicator will light if any programming data is entered incorrectly or the function is rejected. If a red indicator is seen, the entire function (option code + data) will have to be fully re-entered.

### Program the first user code

- Step 1. Enter: **#9# 123456** Enter the program mode (default master code)
- Step 2. Enter: **03# 4#** Set the entry code length to 4 digits
- Step 3. Enter: **21# 5#** Set the main relay activate time to 5 sec.
- Step 4. Enter: **01# 9876# 9876# 1#** Set user code '9876' to activate the main relay
- Step 5. Enter: **\*\* #** Exit programming mode

### Test your new user code

Enter user code '9876'. The green indicator should illuminate, the main relay should activate and the door should unlock for 5 seconds.

### Adding additional user codes

Once the code length and relay time have been set you do not need to set them each time you add additional users.

To add additional users:

- Step 1. Enter: **#9# 123456** Enter the program mode (default master code)
- Step 2. Enter: **01# 2222# 2222# 1#** Set user code '2222' to activate the main relay
- Step 3. Enter: **01# 3333# 3333# 1#** Set user code '3333' to activate the main relay
- Step 4. Enter: **\*\* #** Exit programming mode

### Deleting a user code

To delete a user:

- Step 1. Enter: **#9# 123456** Enter the program mode (default master code)
- Step 2. Enter: **02# 3333# 3333#** User code '3333' has been deleted.
- Step . Enter: **\*\*#** Exit programming mode

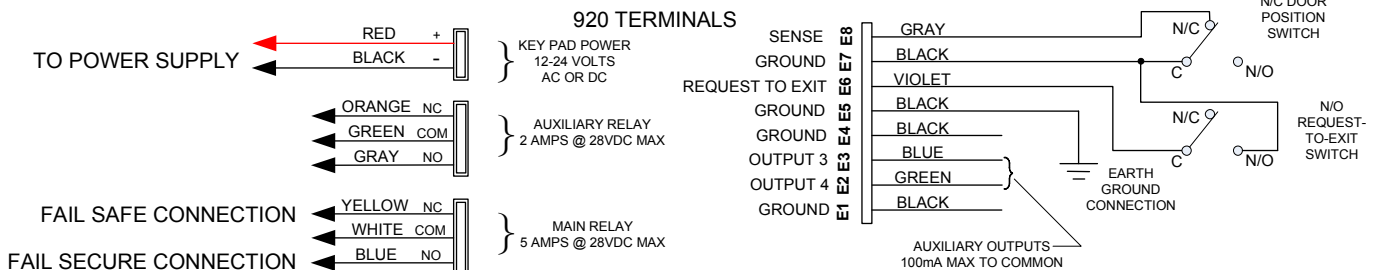
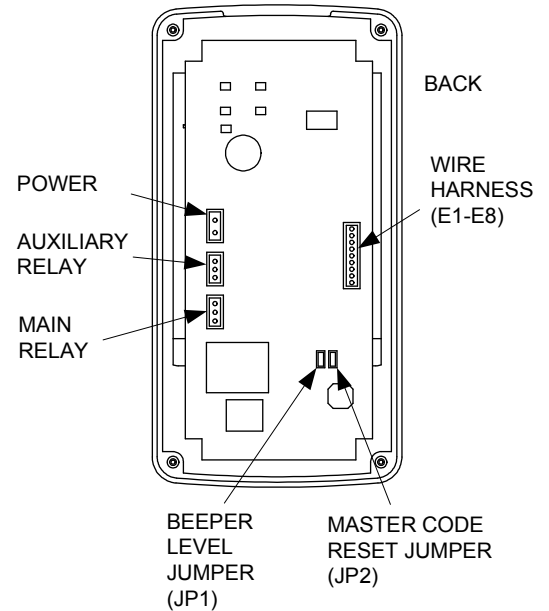
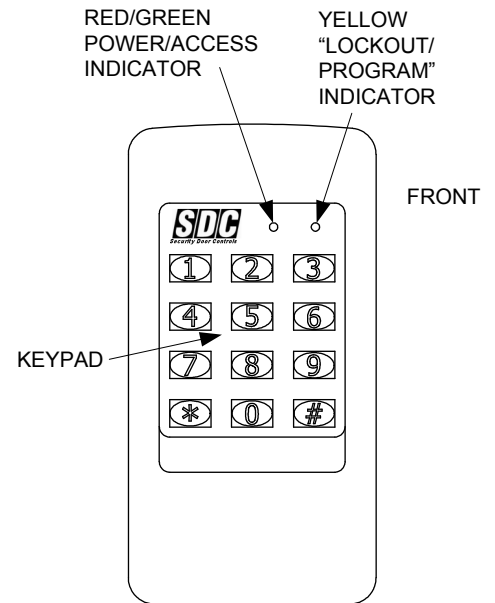

Fig. 2 Wiring Pigtail Color Code



**CAUTION**  
IF THE UNIT IS AC POWERED, MAKE SURE THAT THE SECONDARY OF THE SYSTEM IS ISOLATED FROM EARTH GROUND

## KEYPAD WIRING

See Fig. 3 for an example of a basic door installation. The keypad is mounted adjacent to the door. An electric door strike is mounted in the door jamb to release the door lock. A magnetic switch is mounted on top of the door jamb for detecting when the door is open.

Use the following steps to wire the keypad. Refer to the wiring diagram shown in Fig. 4 to assist in the wiring.

*Note: Up to 500 feet of 18 AWG wire can be run for power, use larger wire for longer runs. Use 22 AWG or larger (depending on load) for other connections.*

### Output

- ❑ Install a low voltage electric door strike for unlocking the door.
- ❑ Route two wires between the door strike and the keypad box.
- ❑ Connect a MOV or varistor across the coil wires of the strike.
- ❑ Connect the (+) door strike wire to the keypad's MAIN RELAY N.O. blue wire. Connect the other door strike wire to the keypad's PWR black wire (-). Connect a wire between the keypad's PWR red wire (+) and the MAIN RELAY COM white wire.

### Power

- ❑ Choose a location for the DC power supply or AC transformer.
- ❑ Route two wires between the door strike and the keypad box. Connect the power supply's output terminals to the keypad's PWR red (+) and black (-) input wires. Observe wiring polarity if using DC. If AC is being used, polarity does not matter.

*Caution: If the unit is AC powered, make sure the secondary of the system transformer is isolated from earth ground.*

### Earth Ground

- ❑ To avoid damage to the unit from static discharges, connect the EARTH GROUND black wires E1, 4, 5 or 8 to a good earth grounding point. Suggested wiring size is 18 AWG for earth ground.

### Sense Input

*RE Note: The SENSE input (gray wire) can be programmed for either a door sense or inhibit input. Both features cannot be used at the same time. If you are not using the sense input, program the input for inhibit.*

- ❑ To use the door sense feature to detect forced entry or door ajar conditions, install a normally closed door switch on the door and route two wires from the switch to the keypad box. Connect the door switch to the keypad's SENSE terminal (gray wire E8) and COM terminal (any black wire).
- ❑ If an inhibit switch or timer is going to be used for temporarily disabling the keypad, route two wires from the switch or timer to the keypad box. Connect the inhibit switch/timer normally open terminals to the keypad's SENSE (gray wire E8) and COM (black wires) terminal.

### Request-to-Exit Input (wiring shown on page 3, fig. 4)

- ❑ If a request-to-exit pushbutton is going to be used, route two wires from the keypad box to a normally open pushbutton mounted on the secure side of the door. Connect the wires to the pushbutton and to the keypad's REX (violet wire E6) and COM (black wires) terminals.

### Solid State Outputs

The two solid state outputs (Outputs #3 & #4) can be programmed to activate during various conditions. These outputs can be used to activate indicators or sounders. See fig. 5 for wiring examples using the solid state outputs.

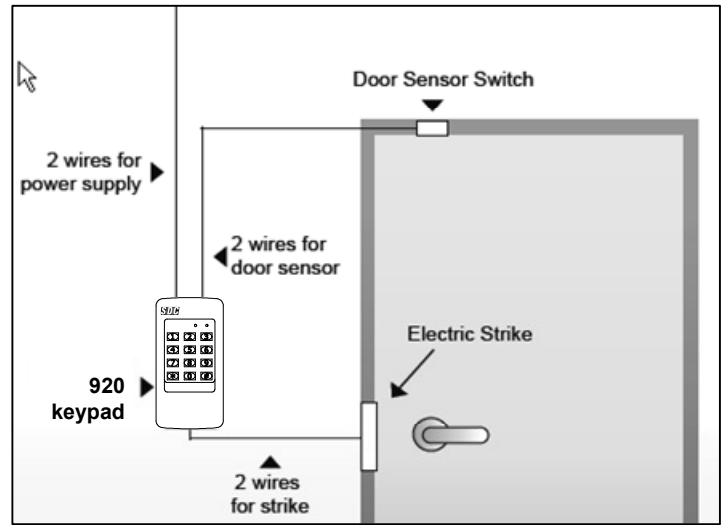

Fig. 3 Basic Door Installation

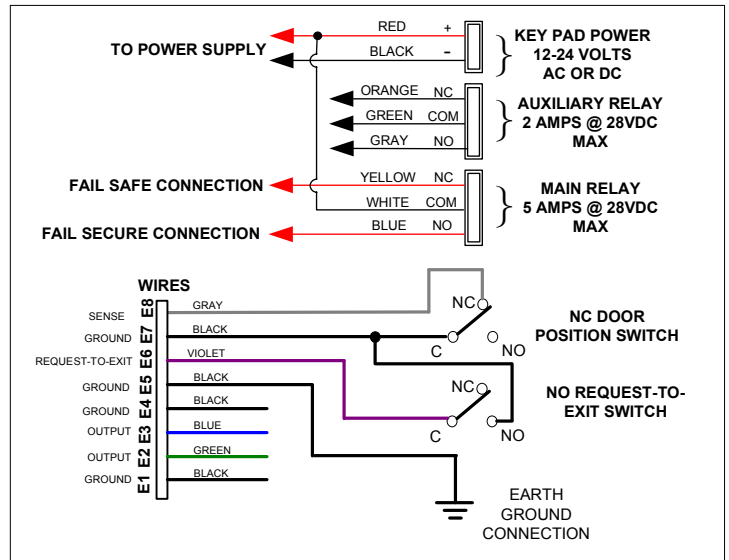

Fig. 4 Basic Door Installation Wiring

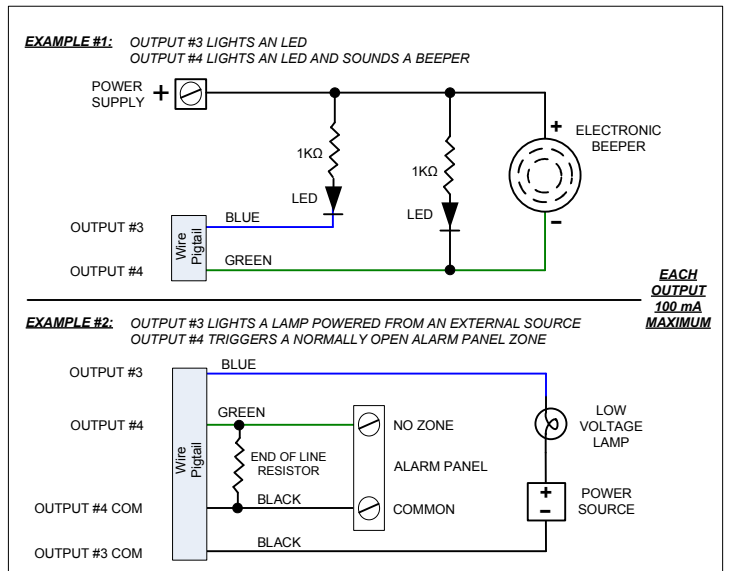

Fig. 5 Using Solid State Outputs

## FACTORY DEFAULTS

Master Programming Code.....	123456
Entry Code Length.....	4 digits
Request-to-exit Output Relay.....	Main Relay
Alarm Shunt Output.....	Disabled
Forced Entry Output.....	Output #3
Door Ajar Output.....	Output #4
Main Relay On Time.....	02 Seconds
Auxiliary Relay On Time.....	02 Seconds
Solid State Output #3 On Time.....	02 Seconds
Solid State Output #4 On Time.....	02 Seconds
Door Sense/Inhibit Input.....	Door Sense
Keypad Lockout Output.....	Disabled
Keypad Active Output.....	Disabled
Beeper Sounds When Key Pressed.....	Yes
Beeper Sounds During Relay #1.....	No
Beeper Sounds During Relay #2.....	No
Beeper Sounds During Output #3.....	No
Beeper Sounds During Output #4.....	No
Keypad Lockout Count.....	3 Tries Before Lockout
Anti-Passback Time.....	No Anti-Passback
Auto-Relock.....	On

## BASIC PROGRAMMING

When the 920 EntryCheck™ is in Programming Mode, both indicators will turn off until programming begins. After a programming option number is entered, the yellow indicator will blink. This shows that the 920 is ready to accept the new programming data. After the new data entry is complete, the yellow indicator will flash while the data is being stored. The green indicator will light if the data is accepted. The red indicator will light if any programming data is entered incorrectly, and the command will have to be fully re-entered.

### Entering Programming Mode

The 6-digit Master Programming Code (default = 123456) is used to enter Programming Mode.

**Press: # 9 # Master Code**

*Master Code = the current 6-digit Master Programming Code*

### Exiting Programming Mode

**Press: \*\*#**

The red indicator will light after exiting Programming Mode

**Note:** *The 920 will automatically exit Programming Mode after two minutes of inactivity*

### Re-entering a Command After a Mistake

If the red indicator lights, signaling an incorrect entry, or an incorrect key is pressed during programming, to clear the keypad and re-enter the command:

**Press: \* 9 #**

### Setting Entry Code Length

**Default: 4 digits**

**Press: 0 3 # Length #**

*Length = 1-6 for entry code length*

**Note:** *If the Entry Code Length is going to be changed from the factory default of 4 digits, make this change first before programming any entry codes.*

## Adding a New Entry Code

**Press: 0 1 # Code # Code # Relay #**

**Code=***The new entry code: 1-999999, depending on code length*

**Relay=***Relay output entry code will activate:*

*1=Main Relay 2=Auxiliary Relay 3=Both Relays*

*10=Relay #1, toggled 20=Relay #2, toggled 30=both Relays toggled*

*12=Relay #1 toggled; Relay #2 timed open*

*21=Relay #1 timed open; Relay #2 toggled*

The yellow indicator will flash quickly while the 920 searches its memory for available space and duplicate entries. The green indicator will light when the new code is stored.

If the new entry code chosen is already being used for another entry code, the red indicator will light. A new unique code needs to be entered.

**Note:** *Leading zeros (zeros before the code number, i.e.0001) do not need to be entered when programming a new code. The 920 will internally add any zeros to fill digits determined by the entry code length setting. Leading zeros will have to be entered by the user when entering their code to gain access.*

## Erasing a Single Entry Code

**Press: 0 2 # Code # Code #**

**Code=***The entry code to delete*

The yellow indicator will flash quickly while the 920 searches its memory for the code to erase. The green indicator will light when the code is erased.

## Erasing All Entry Codes

**WARNING: PERFORMING THIS COMMAND WILL REMOVE ALL ENTRY CODES FROM THE MEMORY**

**Press: 9 7 # 0 0 0 0 0 # 0 0 0 0 0 #**

**Note:** *The green indicator will light while the memory is being erased. This may take up to 15 seconds.*

## Changing the 6-Digit Master Programming Code

**Press: 9 8 # Master Code # Master Code #**

**Master Code=***The new 6-digit Master Programming Code*

New master code: \_\_\_\_\_

## PROGRAMMING OPTIONS

There are several 920 EntryCheck™ programming options. For most installations, the factory set default options are sufficient. The keypad must be in Programming Mode to make these changes.

### Programming the 920 To Hold the Output

SDC's EntryCheck™ products have a programmable "Toggle Mode" available for each relay and solid-state output. When an output is programmed for Toggle Mode, the output alternates from OFF to ON or from ON to OFF each time it is activated. When output is toggled on, the green LED flashes until toggled off.

The rules for a toggle output are:

- *If the output is OFF, it will turn ON and stay on until the next activation.*
- *If the output is ON, it will turn OFF and stay off until the next activation.*

**(Typical Programming cont.)**

Program all normal entry codes to use the Main Relay (Relay #1), and only Relay #1 as the output relay. Program the code(s) that you want to use to hold the output for an indefinite period to the Auxiliary Relay (Relay #2). See the following example that sets entry codes 1234 for normal and 5678 for toggle operation.

**Press: 0 1 # 1 2 3 4 # 1 2 3 4 # 1 #**

*01=Programming Step; 1234=Entry Code; 1=Main Relay*

**Press: 0 1 # 5 6 7 8 # 5 6 7 8 # 20 #**

*01=Programming Step; 5678=Entry Code; 20=Auxiliary Relay toggle*

**Typical Toggle Mode Wiring**

For devices triggered by a normally open circuit, wire the contacts of the Main and Auxiliary Relays in parallel (see the Figure below). Either relay will be able to trigger the access device. Entry codes programmed for the Auxiliary Relay will be able to hold the output on.

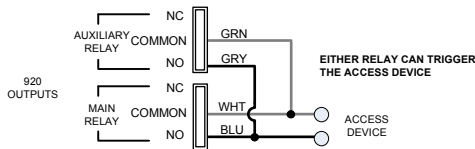

**Select Door Sense or Inhibit Input**      **Default: Door Sense**

The Sense Input (gray wire) can be programmed for either DOOR SENSE or INHIBIT.

**Press: 1 0 # Input #**

*Input=0 for Door Sense; =1 for Inhibit*

When programmed for DOOR SENSE, if an open condition on the input occurs before access is granted (with an entry code or with the request-to-enter input) a FORCED ENTRY output will occur. If an open condition remains after a relay activation for access, a DOOR AJAR output will occur.

When programmed for INHIBIT, a closed condition on the input will prevent Relay #1 from activating when access is requested with an entry code. This mode is typically used with an external timer to disable the access device at certain times.

**Select Forced Entry Output**      **Default: Output #3**

Sets which output activates if the DOOR SENSE input opens before access is granted. This output is not timed.

**Press: 1 1 # Output #**

*Output=Output to Activate(0-4)*

*1=Main Relay; 2=Auxiliary Relay; 3=Output #3; 4=Output #4; 0=No Output*

**Select Door Ajar Output**      **Default: Output #4**

Sets which output activates if the DOOR SENSE input stays open 60 seconds after access is granted. This output is not timed.

**Press: 1 2 # Output #**

*Output=Output to Activate (0-4)*

*1=Main Relay; 2=Auxiliary Relay; 3=Output #3; 4=Output #4; 0=No Output*

**Select Keypad Lockout Output**      **Default: No Output**

Sets which output activates when the keypad is "locked out" after too many incorrect entry code attempts. The lockout time is 60 seconds.

**Press: 1 3 # Output #**

*Output=Output to Activate (0-4)*

*1=Main Relay; 2 = Auxiliary Relay; 3=Output #3; 4=Output #4; 0=No Output*

**Select Keypad Active Output**      **Default: No Output**

Sets which output activates when any keys are pressed. This output is timed. If toggle mode is selected for the output, the timer value defaults to 2 seconds.

**Press: 1 4 # Output #**

*Output=Output to Activate(0-4)*

*1=Main Relay; 2=Auxiliary Relay; 3=Output #3; 4=Output #4; 0=No Output*

**Select Alarm Shunt Output**      **Default: No Output**

Sets which output activates during the time access is granted. (Use this output of shunt alarm contacts attached to the access door.) This output may be timed or toggled.

**Press: 1 5 # Output #**

*Output=Output to Activate(0-4)*

*1=Main Relay; 2=Auxiliary Relay; 3=Output #3; 4=Output #4; 0=No Output*

**Select Request-to-Exit Output**      **Default: No**

Sets which output activates when the Request-to-Exit input is grounded. This output may be timed or toggled.

**Press: 1 6 # Output #**

*Output=Output to Activate(0-4)*

*1=Main Relay; 2=Auxiliary Relay; 3=Output #3; 4=Output #4; 0=No Output*

**REX input terminates toggle of Main Relay**

**Main Relay On-time**      **Default: 02 Seconds**

Sets the length of time the Main Relay activates when triggered. Green LED is on when Main Relay is active.

**Press: 2 1 # Seconds #**

*Seconds=Output time in seconds (0-60)*

**Auxiliary Relay On-time**      **Default: 02 Seconds**

Sets the length of time the Auxiliary Relay activates when triggered.

**Press: 2 2 # Seconds #**

*Seconds=Output time in seconds (0-60)*

**Solid-state Output #3 On-time**      **Default: 02 Seconds**

Sets the length of time Output #3 activates when triggered.

**Press: 2 3 # Seconds #**

*Seconds=Output time in seconds (0-60), 99=Toggle Mode*

**Solid-state Output #4 On-time**                      **Default: 02 Seconds**

Sets the length of time Output #4 activates when triggered.

**Press: 2 4 # Seconds #**

*Seconds=Output time in seconds (0-60), 99=Toggle Mode*

---

**Beep Sounds on Keystrokes**                      **Default: 1 Second**

Selects whether or not the keypad beeps as each key is pressed.

**Press: 4 0 # Sound #**

*Sound=1 for Yes, =0 for No*

---

**Beep Sounds During Main Relay**                      **Default: No**

Selects whether or not the keypad beeps during Main Relay activation.

**Press: 4 1 # Sound #**

*Sound=1 for Yes, =0 for No*

---

**Beep Sounds During Auxiliary Relay**                      **Default: No**

Selects whether or not the keypad beeps during Auxiliary Relay activation.

**Press: 4 2 # Sound #**

*Sound=1 for Yes, =0 for No*

---

**Beep Sounds During Output #3**                      **Default: No**

Selects whether or not the keypad beeps during Output #3 activation.

**Press: 4 3 # Sound #**

*Sound=1 for Yes, =0 for No*

---

**Beep Sounds During Output #4**                      **Default: No**

Selects whether or not the keypad beeps during Output #4 activation.

**Press: 4 4 # Sound #**

*Sound=1 for Yes, =0 for No*

---

**Keypad Lockout Count**                      **Default: 3 Tries**

Sets the number of incorrect entry code attempts allowed before the keypad "locks out".

**Press: 5 0 # Attempts #**

*Attempts=Number of attempts before lockout (2-7)*

---

**Anti-Pass Back Time**                      **Default: No Anti-Pass Back**

Sets the length of time an entry code will not function after it is used.

**Press: 5 1 # Minutes #**

*Minutes=Time in minutes (1-4), 0=No Anti-passback*

---

**Selects mode for Keypad LED Backlight**                      **Default: 30 Seconds**

Selects whether or not the keypad back light stays OFF, lights for 30 seconds when activated or stays ON.

**Press: 52 # Output #**

*0 = Light always OFF*

*1 = 30 sec light when activated (default)*

*2 = Light always ON*

---

**RESETTING KEYPAD**

**Master Reset**

***CAUTION: Performing a master reset will clear the entire memory of the 920 and return all programmable options to the factory default values. ALL ENTRY CODES WILL BE ERASED.***

- STEP 1** Disconnect power from the keypad.
- STEP 2** Press and hold down the \* and # keys.
- STEP 3** Apply power to the keypad, continue holding the keys down until the red indicator starts flashing
- STEP 4** Release the keys. The red and yellow indicators will remain lit until the process is complete, then the yellow indicator will go out.

**Resetting the Master Code**

- STEP 1** Remove the 920 from the wall..
- STEP 2** Locate jumper at JP2. This jumper is used to reset the master code.
- STEP 3** With power applied to the keypad, remove the jumper at JP2. The keypad will begin to beep, signaling that the code has been reset.
- STEP 4** Replace jumper on JP2  
THE MASTER PROGRAMMING CODE IS NOW 123456.

**Beeper Sound Level**

The Keypad's beeper can be set to high or low level. Remove jumper JP1 to reduce beeper sound level.

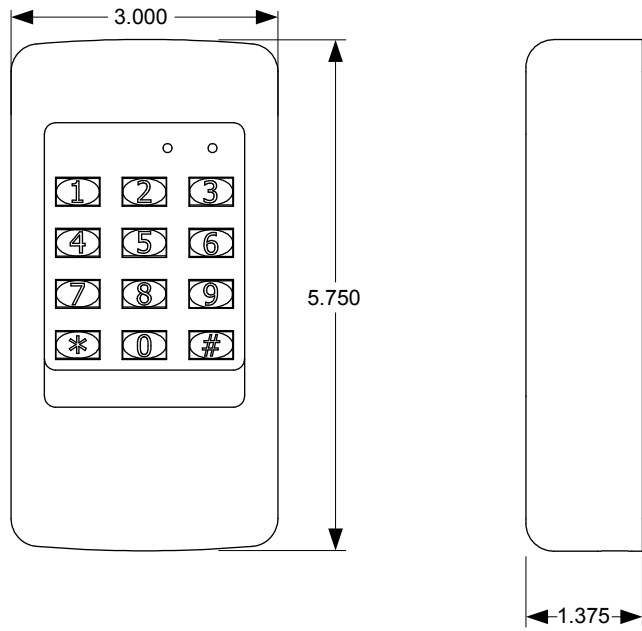

## SURFACE MOUNT

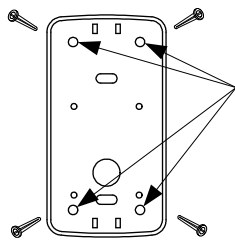

4X Mount at holes  
With supplied  
screws and hole  
expansion anchors

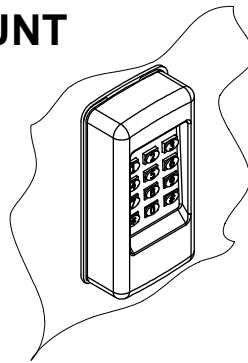

## MOUNTING TO SINGLE GANG RECESSED OUTLET BOX

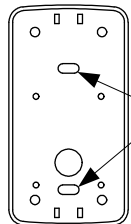

2X  
Mount  
at slots

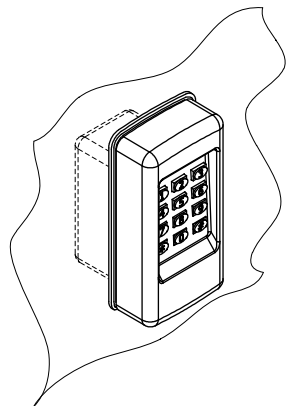
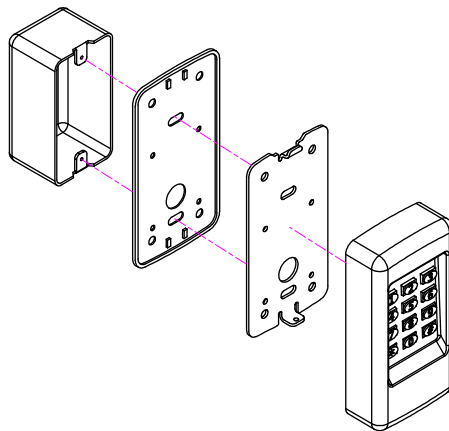

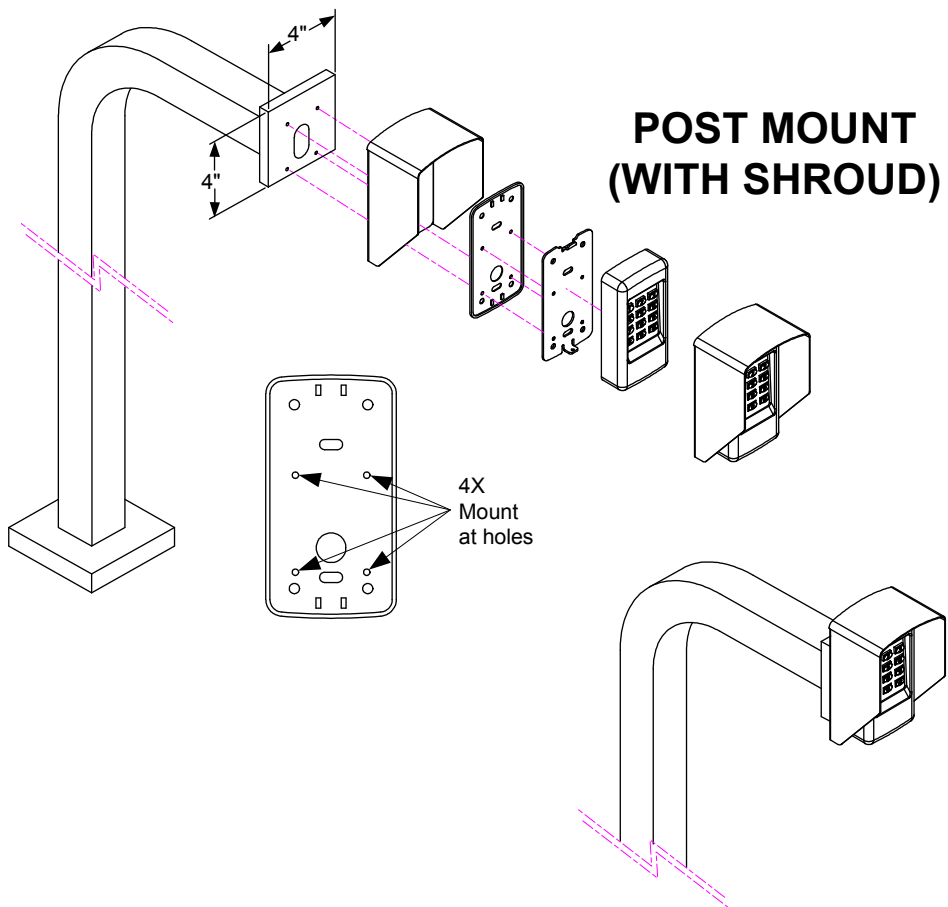
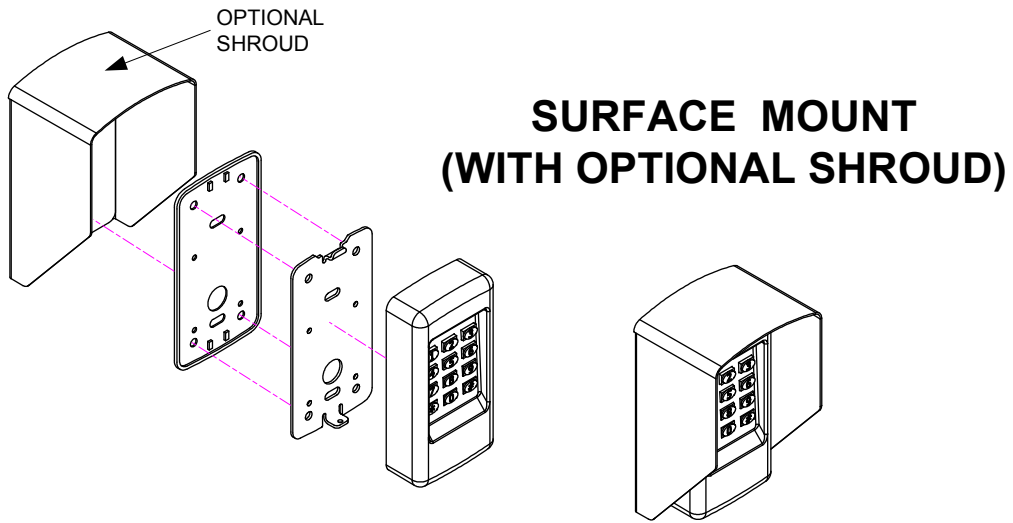



# SDC Security Door Controls

801 Avenida Acaso, Camarillo, Ca. 93012 • (805) 494-0622 •  
www.sdcsecurity.com • E-mail: service@sdsecurity.com

## INSTALLATION INSTRUCTIONS 920 EntryCheck™

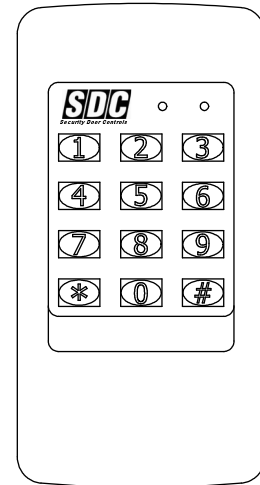

The 920 Indoor/Outdoor Keypad Surface Mount *EntryCheck*™ is a digital keyless entry system designed for access control applications. The keypad is integrated in a heavy cast vandal resistant housing, designed to be mounted on a rugged, surface mounting plate and may be mounted in a standard single-gang electrical box. The indoor/outdoor backlit keys have bright, easy-to-read graphics.

Up to 500 entry codes, from 1 to 6 digits in length, can be programmed. They can activate either, or both of the relay outputs. The “anti-passback” feature prevents using the same code again before the programmed time elapses.

All system indicators are long-lasting, solid state LEDs. Two indicators show the status of the entry system. The left indicator lights red to indicate power, then turns green when access is granted. The right indicator lights yellow when the keypad is in “lockout” condition (from too many incorrect code entries). The yellow LED flashes when the keypad is in programming mode. An internal sounder beeps when each key is pressed. An internal jumper sets the sounder volume high or low

The **SENSE** input can be used two ways. If programmed for “door sense” the input is wired to a normally closed switch on the door to detect when the door is opened or closed. Forced entry or door ajar situations can then be detected. Using door sense, the “Auto-relock” feature will prevent “tailgating” by turning off the Main Relay output immediately when the door is closed after access has been granted. If the **SENSE** input is programmed for “inhibit”, the input can be wired to a “service” switch or automatic timer that will disable the Main Relay when required.

The **REQUEST-TO-EXIT** input can be wired to a pushbutton to provide codeless activation of Main Relay, Auxiliary Relay, Output #3 or Output #4 (programmable).

The **ALARM SHUNT** output activates when access is granted. This output can be wired to shunt alarm contacts on the access door/gate to prevent triggering of an alarm when authorized access occurs.

The 920 *EntryCheck*™ is powered from a 12-24V AC or DC source. The EEPROM memory retains all entry codes and programming, even without power. An internal jumper is provided to reset the master code. The Main Relay has a 5 Amp capacity. The Auxiliary Relay has a 2 Amp capacity. Two solid state outputs, capable of switching 100 mA to common, are programmable to signal forced entry, door ajar, lockout, alarm circuit shunting, request-to-exit, and keypad active conditions.

### Features

- Keypad programmable
- 500 user codes
- 1 to 6 digit user codes
- 4 independent outputs
- 4 independent timers
- 2 Form C relay contacts
- 2 solid state open collector outputs
- Program entry codes to activate one or two relays
- Disable input
- Door sense input
- Request-to-exit/enter input
- Keypad tamper lockout
- Timed anti-passback
- Anti-tailgate
- Two LED status indicators
- Tactile key feel
- Audible code entry verification
- 12 or 24V, AC or DC operation

### SPECIFICATIONS

#### Mechanical

Dimensions: 3.00" W x 5.75" H x 1.375" D  
(1.4375" wall projection)

#### Electrical

Input Voltage: 12-24 Volts AC or DC

Operating Current: 30 mA typical, 150 mA max

#### Output Ratings

Main Relay: Form “C” 5 Amps @ 28 Volts max

Auxiliary Relay: Form “C” 2 Amp @ 28 Volts max

Type: Solid state outputs (Outputs #3 & #4)

Short-to-common 100 mA @ 24 VDC maximum

#### Environmental

Temperature: -22°F to 149°F (-30°C to 65°C)

Humidity: 5% to 95% non-condensing

Any suggestions or comments to this instruction or product are welcome. Please contact us through our website or email [engineer@sdsecurity.com](mailto:engineer@sdsecurity.com)

## QuickStart Programming

To enter Programming Mode, enter #9# plus the Master Code. The yellow indicator will blink slowly showing that the 920 EntryCheck™ is in programming mode. Use the option codes to program each function. After the new data entry is complete for each function, the yellow indicator will flash quickly while the data is being stored and the green indicator will light briefly if the programming has been accepted. The red indicator will light if any programming data is entered incorrectly or the function is rejected. If a red indicator is seen, the entire function (option code + data) will have to be fully re-entered.

### Program the first user code

- Step 1. Enter: **#9# 123456** Enter the program mode (default master code)
- Step 2. Enter: **03# 4#** Set the entry code length to 4 digits
- Step 3. Enter: **21# 5#** Set the main relay activate time to 5 sec.
- Step 4. Enter: **01# 9876# 9876# 1#** Set user code '9876' to activate the main relay
- Step 5. Enter: **\*\* #** Exit programming mode

### Test your new user code

Enter user code '9876'. The green indicator should illuminate, the main relay should activate and the door should unlock for 5 seconds.

### Adding additional user codes

Once the code length and relay time have been set you do not need to set them each time you add additional users.

To add additional users:

- Step 1. Enter: **#9# 123456** Enter the program mode (default master code)
- Step 2. Enter: **01# 2222# 2222# 1#** Set user code '2222' to activate the main relay
- Step 3. Enter: **01# 3333# 3333# 1#** Set user code '3333' to activate the main relay
- Step 4. Enter: **\*\* #** Exit programming mode

### Deleting a user code

To delete a user:

- Step 1. Enter: **#9# 123456** Enter the program mode (default master code)
- Step 2. Enter: **02# 3333# 3333#** User code '3333' has been deleted.
- Step . Enter: **\*\*#** Exit programming mode

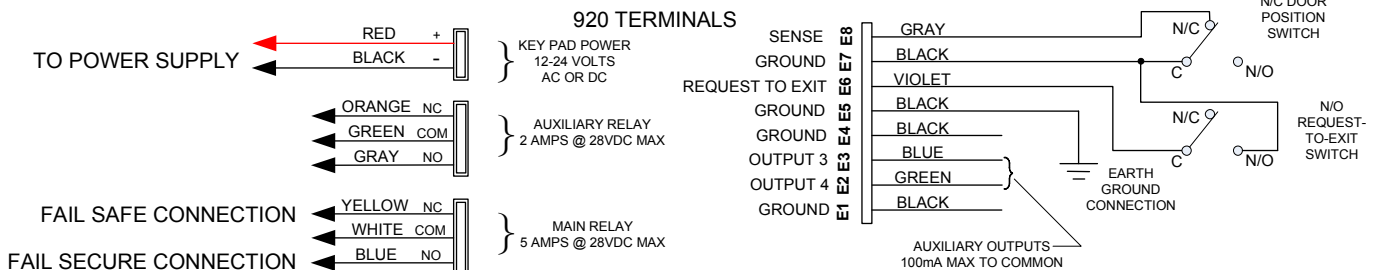
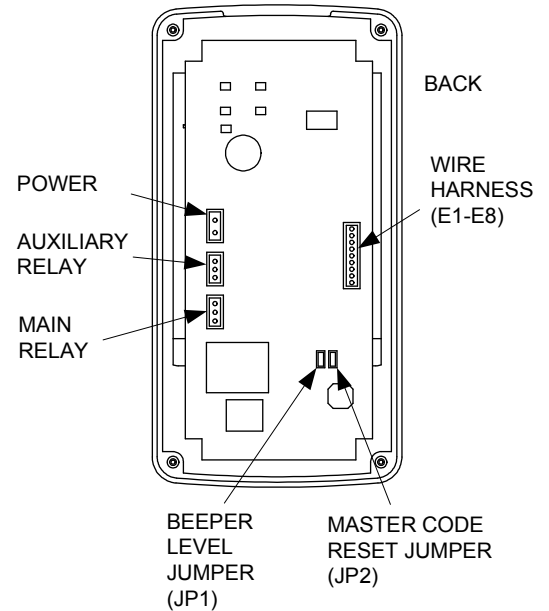
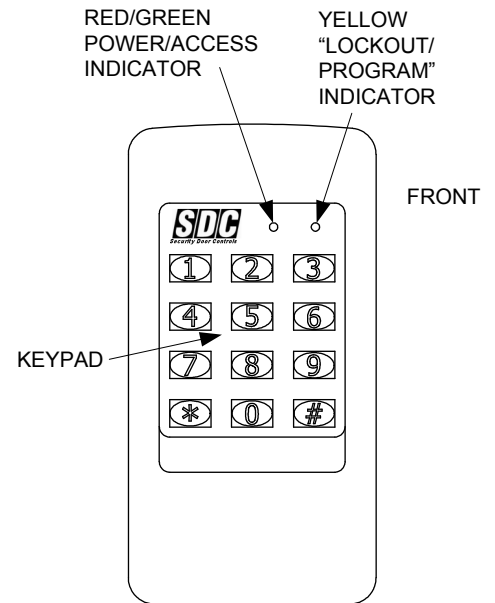

Fig. 2 Wiring Pigtail Color Code



**CAUTION**  
IF THE UNIT IS AC POWERED, MAKE SURE THAT THE SECONDARY OF THE SYSTEM IS ISOLATED FROM EARTH GROUND

## KEYPAD WIRING

See Fig. 3 for an example of a basic door installation. The keypad is mounted adjacent to the door. An electric door strike is mounted in the door jamb to release the door lock. A magnetic switch is mounted on top of the door jamb for detecting when the door is open.

Use the following steps to wire the keypad. Refer to the wiring diagram shown in Fig. 4 to assist in the wiring.

*Note: Up to 500 feet of 18 AWG wire can be run for power, use larger wire for longer runs. Use 22 AWG or larger (depending on load) for other connections.*

### Output

- ❑ Install a low voltage electric door strike for unlocking the door.
- ❑ Route two wires between the door strike and the keypad box.
- ❑ Connect a MOV or varistor across the coil wires of the strike.
- ❑ Connect the (+) door strike wire to the keypad's MAIN RELAY N.O. blue wire. Connect the other door strike wire to the keypad's PWR black wire (-). Connect a wire between the keypad's PWR red wire (+) and the MAIN RELAY COM white wire.

### Power

- ❑ Choose a location for the DC power supply or AC transformer.
- ❑ Route two wires between the door strike and the keypad box. Connect the power supply's output terminals to the keypad's PWR red (+) and black (-) input wires. Observe wiring polarity if using DC. If AC is being used, polarity does not matter.

*Caution: If the unit is AC powered, make sure the secondary of the system transformer is isolated from earth ground.*

### Earth Ground

- ❑ To avoid damage to the unit from static discharges, connect the EARTH GROUND black wires E1, 4, 5 or 8 to a good earth grounding point. Suggested wiring size is 18 AWG for earth ground.

### Sense Input

*RE Note: The SENSE input (gray wire) can be programmed for either a door sense or inhibit input. Both features cannot be used at the same time. If you are not using the sense input, program the input for inhibit.*

- ❑ To use the door sense feature to detect forced entry or door ajar conditions, install a normally closed door switch on the door and route two wires from the switch to the keypad box. Connect the door switch to the keypad's SENSE terminal (gray wire E8) and COM terminal (any black wire).
- ❑ If an inhibit switch or timer is going to be used for temporarily disabling the keypad, route two wires from the switch or timer to the keypad box. Connect the inhibit switch/timer normally open terminals to the keypad's SENSE (gray wire E8) and COM (black wires) terminal.

### Request-to-Exit Input (wiring shown on page 3, fig. 4)

- ❑ If a request-to-exit pushbutton is going to be used, route two wires from the keypad box to a normally open pushbutton mounted on the secure side of the door. Connect the wires to the pushbutton and to the keypad's REX (violet wire E6) and COM (black wires) terminals.

### Solid State Outputs

The two solid state outputs (Outputs #3 & #4) can be programmed to activate during various conditions. These outputs can be used to activate indicators or sounders. See fig. 5 for wiring examples using the solid state outputs.

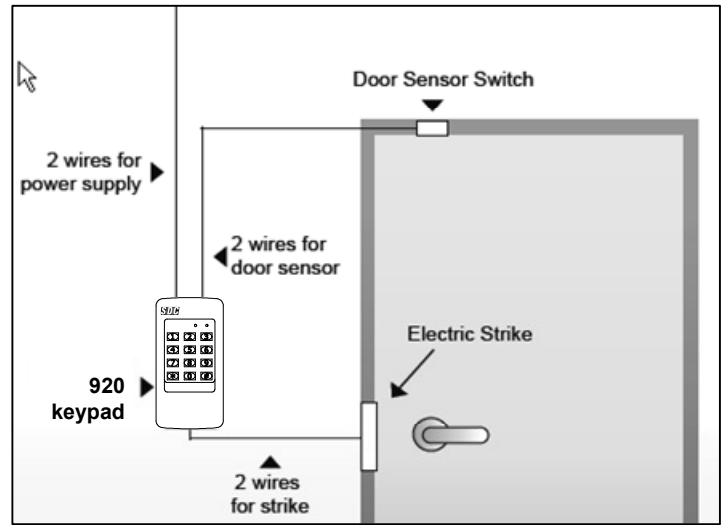

Fig. 3 Basic Door Installation

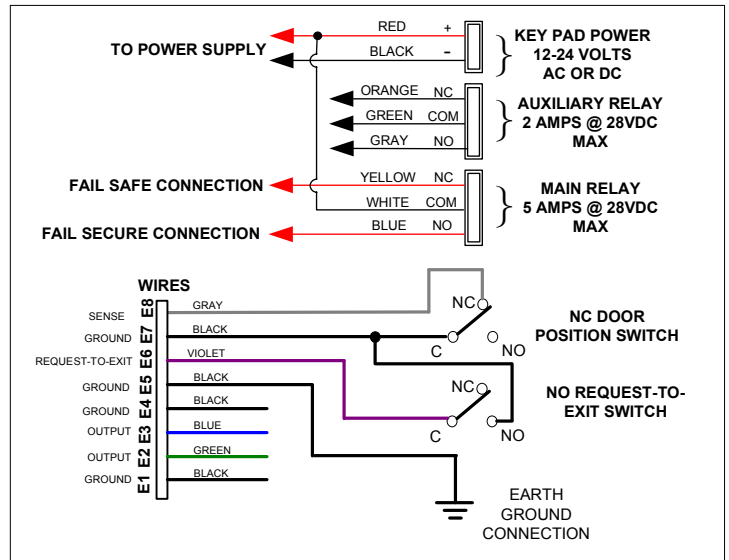

Fig. 4 Basic Door Installation Wiring

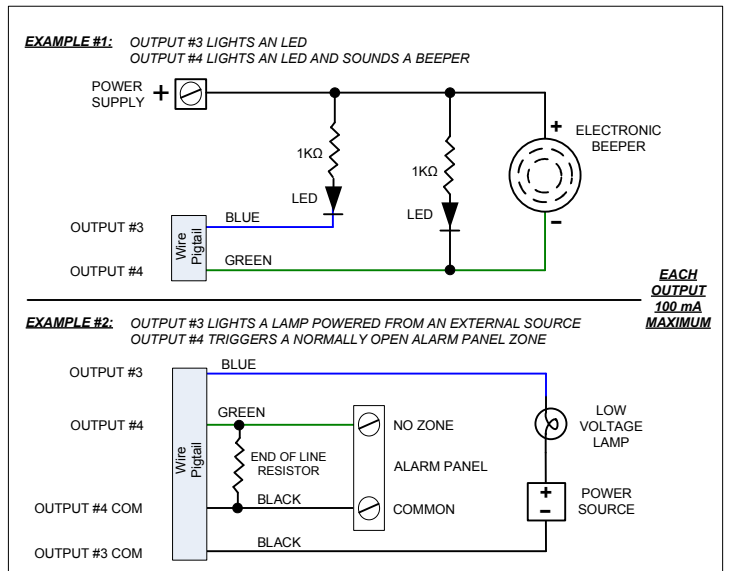

Fig. 5 Using Solid State Outputs

## FACTORY DEFAULTS

Master Programming Code.....	123456
Entry Code Length.....	4 digits
Request-to-exit Output Relay.....	Main Relay
Alarm Shunt Output.....	Disabled
Forced Entry Output.....	Output #3
Door Ajar Output.....	Output #4
Main Relay On Time.....	02 Seconds
Auxiliary Relay On Time.....	02 Seconds
Solid State Output #3 On Time.....	02 Seconds
Solid State Output #4 On Time.....	02 Seconds
Door Sense/Inhibit Input.....	Door Sense
Keypad Lockout Output.....	Disabled
Keypad Active Output.....	Disabled
Beeper Sounds When Key Pressed.....	Yes
Beeper Sounds During Relay #1.....	No
Beeper Sounds During Relay #2.....	No
Beeper Sounds During Output #3.....	No
Beeper Sounds During Output #4.....	No
Keypad Lockout Count.....	3 Tries Before Lockout
Anti-Passback Time.....	No Anti-Passback
Auto-Relock.....	On

## BASIC PROGRAMMING

When the 920 EntryCheck™ is in Programming Mode, both indicators will turn off until programming begins. After a programming option number is entered, the yellow indicator will blink. This shows that the 920 is ready to accept the new programming data. After the new data entry is complete, the yellow indicator will flash while the data is being stored. The green indicator will light if the data is accepted. The red indicator will light if any programming data is entered incorrectly, and the command will have to be fully re-entered.

### Entering Programming Mode

The 6-digit Master Programming Code (default = 123456) is used to enter Programming Mode.

**Press: # 9 # Master Code**

*Master Code = the current 6-digit Master Programming Code*

### Exiting Programming Mode

**Press: \*\*#**

The red indicator will light after exiting Programming Mode

**Note:** *The 920 will automatically exit Programming Mode after two minutes of inactivity*

### Re-entering a Command After a Mistake

If the red indicator lights, signaling an incorrect entry, or an incorrect key is pressed during programming, to clear the keypad and re-enter the command:

**Press: \* 9 #**

### Setting Entry Code Length

**Default: 4 digits**

**Press: 0 3 # Length #**

*Length = 1-6 for entry code length*

**Note:** *If the Entry Code Length is going to be changed from the factory default of 4 digits, make this change first before programming any entry codes.*

## Adding a New Entry Code

**Press: 0 1 # Code # Code # Relay #**

**Code=***The new entry code: 1-999999, depending on code length*

**Relay=***Relay output entry code will activate:*

*1=Main Relay 2=Auxiliary Relay 3=Both Relays*

*10=Relay #1, toggled 20=Relay #2, toggled 30=both Relays toggled*

*12=Relay #1 toggled; Relay #2 timed open*

*21=Relay #1 timed open; Relay #2 toggled*

The yellow indicator will flash quickly while the 920 searches its memory for available space and duplicate entries. The green indicator will light when the new code is stored.

If the new entry code chosen is already being used for another entry code, the red indicator will light. A new unique code needs to be entered.

**Note:** *Leading zeros (zeros before the code number, i.e.0001) do not need to be entered when programming a new code. The 920 will internally add any zeros to fill digits determined by the entry code length setting. Leading zeros will have to be entered by the user when entering their code to gain access.*

## Erasing a Single Entry Code

**Press: 0 2 # Code # Code #**

**Code=***The entry code to delete*

The yellow indicator will flash quickly while the 920 searches its memory for the code to erase. The green indicator will light when the code is erased.

## Erasing All Entry Codes

**WARNING: PERFORMING THIS COMMAND WILL REMOVE ALL ENTRY CODES FROM THE MEMORY**

**Press: 9 7 # 0 0 0 0 0 # 0 0 0 0 0 #**

**Note:** *The green indicator will light while the memory is being erased. This may take up to 15 seconds.*

## Changing the 6-Digit Master Programming Code

**Press: 9 8 # Master Code # Master Code #**

**Master Code=***The new 6-digit Master Programming Code*

New master code: \_\_\_\_\_

## PROGRAMMING OPTIONS

There are several 920 EntryCheck™ programming options. For most installations, the factory set default options are sufficient. The keypad must be in Programming Mode to make these changes.

### Programming the 920 To Hold the Output

SDC's EntryCheck™ products have a programmable "Toggle Mode" available for each relay and solid-state output. When an output is programmed for Toggle Mode, the output alternates from OFF to ON or from ON to OFF each time it is activated. When output is toggled on, the green LED flashes until toggled off.

The rules for a toggle output are:

- *If the output is OFF, it will turn ON and stay on until the next activation.*
- *If the output is ON, it will turn OFF and stay off until the next activation.*

**(Typical Programming cont.)**

Program all normal entry codes to use the Main Relay (Relay #1), and only Relay #1 as the output relay. Program the code(s) that you want to use to hold the output for an indefinite period to the Auxiliary Relay (Relay #2). See the following example that sets entry codes 1234 for normal and 5678 for toggle operation.

**Press: 0 1 # 1 2 3 4 # 1 2 3 4 # 1 #**

*01=Programming Step; 1234=Entry Code; 1=Main Relay*

**Press: 0 1 # 5 6 7 8 # 5 6 7 8 # 20 #**

*01=Programming Step; 5678=Entry Code; 20=Auxiliary Relay toggle*

**Typical Toggle Mode Wiring**

For devices triggered by a normally open circuit, wire the contacts of the Main and Auxiliary Relays in parallel (see the Figure below). Either relay will be able to trigger the access device. Entry codes programmed for the Auxiliary Relay will be able to hold the output on.

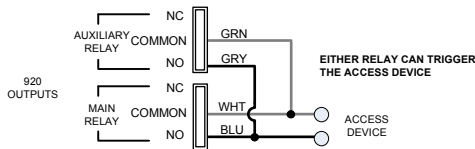

**Select Door Sense or Inhibit Input**      **Default: Door Sense**

The Sense Input (gray wire) can be programmed for either DOOR SENSE or INHIBIT.

**Press: 1 0 # Input #**

*Input=0 for Door Sense; =1 for Inhibit*

When programmed for DOOR SENSE, if an open condition on the input occurs before access is granted (with an entry code or with the request-to-enter input) a FORCED ENTRY output will occur. If an open condition remains after a relay activation for access, a DOOR AJAR output will occur.

When programmed for INHIBIT, a closed condition on the input will prevent Relay #1 from activating when access is requested with an entry code. This mode is typically used with an external timer to disable the access device at certain times.

**Select Forced Entry Output**      **Default: Output #3**

Sets which output activates if the DOOR SENSE input opens before access is granted. This output is not timed.

**Press: 1 1 # Output #**

*Output=Output to Activate(0-4)*

*1=Main Relay; 2=Auxiliary Relay; 3=Output #3; 4=Output #4; 0=No Output*

**Select Door Ajar Output**      **Default: Output #4**

Sets which output activates if the DOOR SENSE input stays open 60 seconds after access is granted. This output is not timed.

**Press: 1 2 # Output #**

*Output=Output to Activate (0-4)*

*1=Main Relay; 2=Auxiliary Relay; 3=Output #3; 4=Output #4; 0=No Output*

**Select Keypad Lockout Output**      **Default: No Output**

Sets which output activates when the keypad is "locked out" after too many incorrect entry code attempts. The lockout time is 60 seconds.

**Press: 1 3 # Output #**

*Output=Output to Activate (0-4)*

*1=Main Relay; 2 = Auxiliary Relay; 3=Output #3; 4=Output #4; 0=No Output*

**Select Keypad Active Output**      **Default: No Output**

Sets which output activates when any keys are pressed. This output is timed. If toggle mode is selected for the output, the timer value defaults to 2 seconds.

**Press: 1 4 # Output #**

*Output=Output to Activate(0-4)*

*1=Main Relay; 2=Auxiliary Relay; 3=Output #3; 4=Output #4; 0=No Output*

**Select Alarm Shunt Output**      **Default: No Output**

Sets which output activates during the time access is granted. (Use this output of shunt alarm contacts attached to the access door.) This output may be timed or toggled.

**Press: 1 5 # Output #**

*Output=Output to Activate(0-4)*

*1=Main Relay; 2=Auxiliary Relay; 3=Output #3; 4=Output #4; 0=No Output*

**Select Request-to-Exit Output**      **Default: No**

Sets which output activates when the Request-to-Exit input is grounded. This output may be timed or toggled.

**Press: 1 6 # Output #**

*Output=Output to Activate(0-4)*

*1=Main Relay; 2=Auxiliary Relay; 3=Output #3; 4=Output #4; 0=No Output*

**REX input terminates toggle of Main Relay**

**Main Relay On-time**      **Default: 02 Seconds**

Sets the length of time the Main Relay activates when triggered. Green LED is on when Main Relay is active.

**Press: 2 1 # Seconds #**

*Seconds=Output time in seconds (0-60)*

**Auxiliary Relay On-time**      **Default: 02 Seconds**

Sets the length of time the Auxiliary Relay activates when triggered.

**Press: 2 2 # Seconds #**

*Seconds=Output time in seconds (0-60)*

**Solid-state Output #3 On-time**      **Default: 02 Seconds**

Sets the length of time Output #3 activates when triggered.

**Press: 2 3 # Seconds #**

*Seconds=Output time in seconds (0-60), 99=Toggle Mode*

**Solid-state Output #4 On-time**                      **Default: 02 Seconds**

Sets the length of time Output #4 activates when triggered.

**Press: 2 4 # Seconds #**

*Seconds=Output time in seconds (0-60), 99=Toggle Mode*

---

**Beep Sounds on Keystrokes**                      **Default: 1 Second**

Selects whether or not the keypad beeps as each key is pressed.

**Press: 4 0 # Sound #**

*Sound=1 for Yes, =0 for No*

---

**Beep Sounds During Main Relay**                      **Default: No**

Selects whether or not the keypad beeps during Main Relay activation.

**Press: 4 1 # Sound #**

*Sound=1 for Yes, =0 for No*

---

**Beep Sounds During Auxiliary Relay**                      **Default: No**

Selects whether or not the keypad beeps during Auxiliary Relay activation.

**Press: 4 2 # Sound #**

*Sound=1 for Yes, =0 for No*

---

**Beep Sounds During Output #3**                      **Default: No**

Selects whether or not the keypad beeps during Output #3 activation.

**Press: 4 3 # Sound #**

*Sound=1 for Yes, =0 for No*

---

**Beep Sounds During Output #4**                      **Default: No**

Selects whether or not the keypad beeps during Output #4 activation.

**Press: 4 4 # Sound #**

*Sound=1 for Yes, =0 for No*

---

**Keypad Lockout Count**                      **Default: 3 Tries**

Sets the number of incorrect entry code attempts allowed before the keypad "locks out".

**Press: 5 0 # Attempts #**

*Attempts=Number of attempts before lockout (2-7)*

---

**Anti-Pass Back Time**                      **Default: No Anti-Pass Back**

Sets the length of time an entry code will not function after it is used.

**Press: 5 1 # Minutes #**

*Minutes=Time in minutes (1-4), 0=No Anti-passback*

---

**Selects mode for Keypad LED Backlight**                      **Default: 30 Seconds**

Selects whether or not the keypad back light stays OFF, lights for 30 seconds when activated or stays ON.

**Press: 52 # Output #**

*0 = Light always OFF*

*1 = 30 sec light when activated (default)*

*2 = Light always ON*

---

**RESETTING KEYPAD**

**Master Reset**

***CAUTION: Performing a master reset will clear the entire memory of the 920 and return all programmable options to the factory default values. ALL ENTRY CODES WILL BE ERASED.***

- STEP 1** Disconnect power from the keypad.
- STEP 2** Press and hold down the \* and # keys.
- STEP 3** Apply power to the keypad, continue holding the keys down until the red indicator starts flashing
- STEP 4** Release the keys. The red and yellow indicators will remain lit until the process is complete, then the yellow indicator will go out.

**Resetting the Master Code**

- STEP 1** Remove the 920 from the wall.
- STEP 2** Locate jumper at JP2. This jumper is used to reset the master code.
- STEP 3** With power applied to the keypad, remove the jumper at JP2. The keypad will begin to beep, signaling that the code has been reset.
- STEP 4** Replace jumper on JP2  
THE MASTER PROGRAMMING CODE IS NOW 123456.

**Beeper Sound Level**

The Keypad's beeper can be set to high or low level. Remove jumper JP1 to reduce beeper sound level.

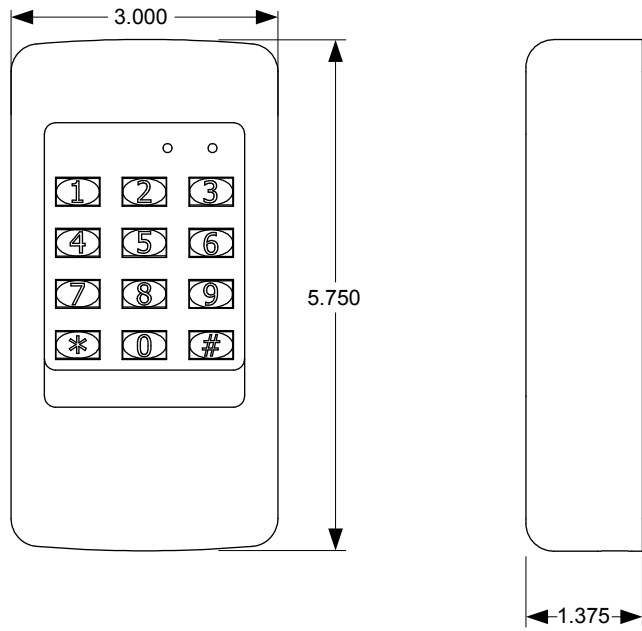

## SURFACE MOUNT

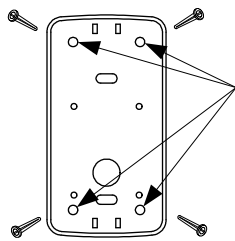

4X Mount at holes  
With supplied  
screws and hole  
expansion anchors

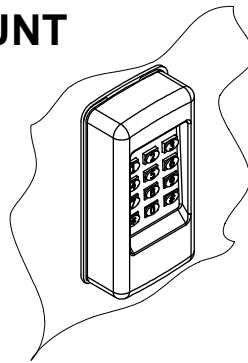

## MOUNTING TO SINGLE GANG RECESSED OUTLET BOX

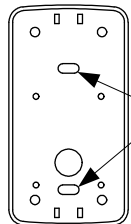

2X  
Mount  
at slots

